

Foreword

Dear users:

Thank you for your trust in Farizon Auto and choosing Farizon vehicles with excellent safety, comfort, power and economy performance. We are looking forward to bringing fun to your work and life with high-quality products and services.

Please read and abide by the contents of this manual before using it for the first time. It will help you better understand and use Farizon vehicles, so that your new vehicle will be in good technical condition and always maintain the best performance in future use. The more you know about your vehicle, the more you can enjoy the safety and fun of driving it.

In case you find some problems during use, please contact a Farizon Auto after-sales service station for maintenance as soon as possible. The service station will provide you with high-quality services in terms of maintenance and repair. Please complete the maintenance on schedule according to the maintenance regulations in this manual.

This manual provides relevant information of all vehicle models. Due to the different configurations of different vehicle models, the description in this manual may be different from the actual configuration of the vehicle you purchased. Please refer to the actual vehicle received.

This manual is an integral part of the vehicle, please keep it properly. When selling or lending this vehicle, please hand over this manual to the new owner.

All materials in this manual are updated to the latest at the time of publication. Any changes in the future will be notified in accordance with relevant regulations.

Happy Life, Geely Drive!

Zhejiang Geely Farizon New Energy
Commercial Vehicle Group Co., Ltd.

November 2023

All rights reserved. Without the written consent of Zhejiang Geely Farizon New Energy Commercial Vehicle Group Co., Ltd., any content in this manual shall not be reproduced or copied.

Note: The cover and pictures of this manual are for reference only. Please refer to the actual vehicle

Introduction and vehicle identification	5	Wiper control combination switch	37
Introduction	5	Steering wheel	38
Notes to users	5	Steering wheel button.....	38
Prompt information.....	6	Horn	39
Graphic information	6	Steering wheel heating*	40
Vehicle identification.....	6	Rear mirror	40
Vehicle identification marking.	6	Exterior rearview mirror	40
Location of vehicle identification mark.....	7	Window.....	42
Vehicle nameplate	9	Precautions	42
Vehicle overview	10	Electric window	42
Battery electric power system ..	13	Interior illumination	43
Introduction to the system.....	13	Interior lamp	43
Overview	13	Cab description	44
HV safety	14	Instrument panel switch group.....	44
Warning information	15	Storage space.....	45
Maintenance, repair, recycling and scrapping.....	16	Backup power supply.....	46
Charging system	18	USB interface.....	46
Precautions for charging.....	18	Interior handle	46
Charging interface	20	Sun visor	47
Charging operation.....	21	Air conditioning and multimedia systems	48
Instrument and control	25	Air conditioning, heating and ventilation	48
Instruments and controls.....	25	Overview of A/C control system.....	48
Cockpit overview	25	Descriptions of A/C control system button	49
Instrument cluster	26	A/C ventilation system	51
Overview of instrument cluster.....	26	Air outlet adjustment and A/C maintenance	52
Driving gauges.....	26	Multimedia system	53
Common Information.....	27	Operation instructions of multimedia player	53
Warning lamps and indicators	29	Seats and protective devices	54
Introduction to warning lamps and indicators.....	31	Seat	54
Light control	34	Driver's seat.....	54
Operation of light control combination switch	34		
Wiper and washer	37		

Passenger seat	56	Troubles in driving	97
Seat ventilation and heating....	56	Hazard warning device	97
Seat adjustment parameters...	57	Hazard warning lamp.....	97
Seat belt.....	58	Warning triangle	97
Overview of seat belt.....	58	Jump start.....	97
Use of seat belt	61	Vehicle jump start.....	97
Seat belt unfastened warning .	62	Traction and towing of vehicles..	99
Maintenance of seat belt	63	Vehicle transportation	99
Airbags	63	Towing hook.....	101
Overview of airbag.....	63	Fuse replacement.....	102
Airbag deployment	65	Fuse location and	
Airbag malfunction indicator...	67	identification	102
Starting and driving.....	69	Chassis fuse box	102
Key.....	69	Instrument fuse box.....	104
Remote control key.....	69	Check or replace the fuse.....	106
Anti-theft System	71	Lamp bulb replacement.....	108
Anti-theft System	71	Bulb specifications.....	108
Vehicle locking and unlocking....	71	Emergency response	109
Unlocking and Locking	71	Vehicle over-temperature.....	109
Vehicle is started.....	74	Vehicle collision.....	110
Start switch	74	Vehicle fire	111
Vehicle starting procedure.....	75	Getting vehicle out of trap.....	111
Vehicle start failure.....	75	On-board tools	112
Driving precautions	76	On-board tools.....	112
Gearshift operation	82	Repair and Maintenance	113
Shift information	82	Maintenance	113
Brake and assist systems	84	Regular maintenance	113
Service brake	84	Front engine compartment.....	114
Mechanical parking brake.....	85	Front engine compartment....	114
Electronic stability control		Cooling system	115
system (ESC)	86	Introduction to cooling	
Parking assist system.....	90	system.....	115
Reversing radar system.....	90	Check the coolant	115
Reversing image.....	92	Adding of coolant	116
Intelligent driving system	93	Brake system	117
Acoustic vehicle alerting		Precautions for Brake System.	117
system	93	Braking energy recovery.....	119
Loading	94	Brake fluid	119
Cargo car body	94	Power steering	120

Table of Contents

EPS	120	Main parameters of power battery.....	141
Front combination light	120	Vehicle dynamics	142
Fogging in headlamp cluster ...	120	Wheel and tire parameters	142
Low-voltage battery.....	121	Oil	143
Utilization and maintenance of battery	121	Recommended oil and capacity.....	143
Battery inspection.....	122	Index	144
Charging or Replacing the Battery.....	123		
Long-term storage of vehicles.	124		
Washer fluid and wiper blade.....	124		
Washer fluid.....	124		
Wiper blade	125		
Tire	126		
Overview	126		
Winter Tire	127		
Tire pressure	127		
Tire Pressure Monitoring System (TPMS).....	127		
Tire inspection and rotation ...	128		
Selection of new tires	130		
Wheel alignment and tire balance	131		
Wheel Replacement.....	132		
Tire chain	132		
In case of a flat tire	133		
Vehicle cleaning and maintenance	133		
External cleaning.....	133		
Interior cleaning.....	135		
Technical data	138		
Main parameters of vehicle	138		
Main dimensional parameters	138		
Vehicle mass parameters.....	139		
Main characteristic parameters of vehicle.....	140		
Main parameters of drive motor.....	141		

Introduction

Notes to users

1. This vehicle is an electric vehicle driven by pure electric power, and its characteristics are different from those of ordinary vehicles. Please familiarize yourself with the characteristics and drive carefully. Please read this manual carefully and follow the instructions. After reading this manual, please keep it properly.
2. Be sure to shift the gear into neutral (N) position and pull up the handbrake during parking operation. When using the vehicle for the first time, please fully charge it. For daily use of the vehicle, make sure that the power battery is not fully charged or discharged.
3. Please accelerate and decelerate as smoothly as possible when driving the vehicle. When the vehicle is running, energy can be recovered through regenerative braking during deceleration. In order to use the vehicle effectively, please avoid unnecessary rapid acceleration or deceleration.
4. Please check the tire wear and tire pressure regularly according to the method recommended in this manual and tire pressure specifications.
5. The electric power system of this vehicle is driven by high voltage. Please observe the warning and caution labels attached to the high-voltage components of the vehicle.
6. Do not touch HV cables (orange), connectors and HV parts (drive motor, power battery, HV auxiliary drive controller, etc.); otherwise, serious injury or even death may be caused.
7. If bare wires extend inside or outside the vehicle, do not touch them; otherwise electric shock may occur.
8. Please leave the vehicle as soon as possible in case of fire. If high-voltage components or wiring harnesses smoke and catch fire, use a high-pressure water gun to put out the fire.
9. Never sell, transfer or modify the power battery. The Farizon Auto after-sales service station shall be responsible for recycling the power batteries removed from end-of-life vehicles to prevent accidents and environmental pollution.
10. It is strictly prohibited to dispose of and store used power batteries personally. Please contact a Farizon Auto after-sales service station for disposal.
11. Do not store the vehicle in an environment with high temperature (55°C) or low temperature (-30°C). Please try to store the vehicle in an area with appropriate temperature.

12. Please use the oil and fluid recommended in this manual, and carry out maintenance as required to effectively prolong the service life of the vehicle.
13. It is strictly prohibited to illegally modify or install any equipment or accessories on our products without permission. Otherwise, we will not bear any responsibility for the direct or indirect losses caused thereby.

Prompt information

High voltage

-  It means that the event stated here is related to the high voltage circuit of pure electric vehicle and must be strictly observed; otherwise, it may lead to electric shock or more serious injury and even death. ◀

Warning

-  Indicates that if the warning is ignored, serious injury or death may result. The steps stated must be strictly followed, or the information provided must be carefully considered. ◀

Caution

-  Indicates that the thing stated here must be strictly observed; otherwise your vehicle may be damaged. ◀

Description

-  As indicative statement, it indicates information with which

you can make better use of your vehicle. ◀





Environmental

-  It indicates that the events stated here are related to environmental protection. ◀

Asterisk*

The asterisk “*” after the title or name indicates that the described device or function is only provided in some models, and the vehicle you purchased may not be equipped.

Graphic information

-  It indicates a description object.
-  It indicates the moving direction of an object.
-  It indicates the rotation direction of the object.
-  It means that it is forbidden to do so or to prevent this from happening.

Vehicle identification

Vehicle identification marking

When you contact a Farizon Auto after-sales service station, the vehicle identification number (VIN) shall be provided. If the drive motor or power battery is involved in your communication with a Farizon Auto after-sales service station, you may need to provide its code.

Location of vehicle identification mark

Location of Vehicle Identification Number (VIN)

Vehicle Identification Number (VIN) is the legal identification mark of the vehicle for owner registration. It can be read in the following ways.

i If the VIN pasted/engraved on the vehicle body is damaged, please contact a Farizon Auto after-sales service station in time. ◀

1. Read on the window at the lower left side of the front windshield.

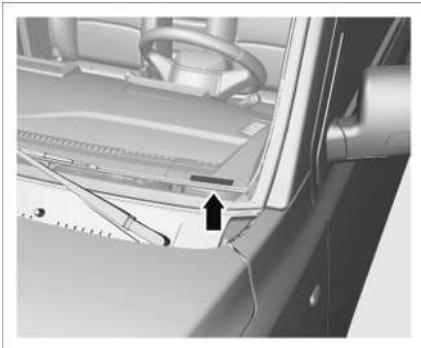

2. Right side of seat at passenger's side.

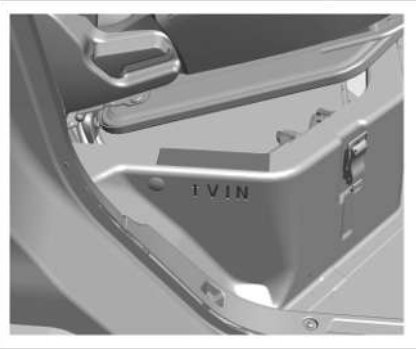

3. Vehicle nameplate.

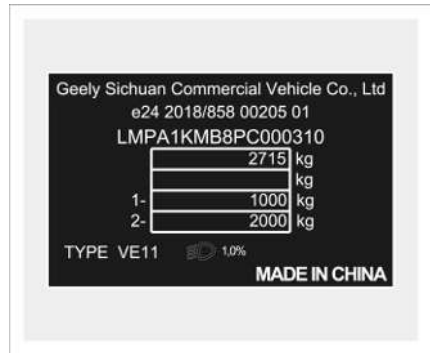

4. The VIN can be read with a vehicle diagnosis tester through the Farizon Auto after-sales service station.

⚠ If the above method is required to read VIN, the data shall be read by professional maintenance personnel of Farizon Auto after-sales service station. Operation by non-professional personnel may cause vehicle failure. ◀

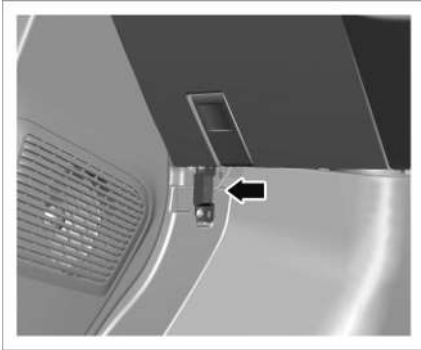

Vehicle identification number (VIN)

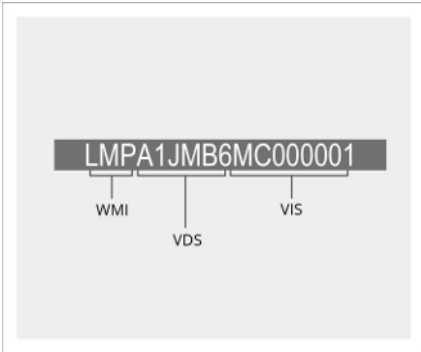

The VIN consists of three parts, namely WMI, VDS, and VIS, in a total of 17 characters. It contains information such as the manufacturer, age, body form, code and assembly place of the vehicle.

Location of drive motor code

The drive motor is installed at the bottom of the vehicle.

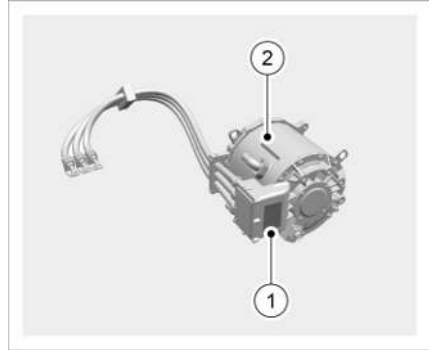

- 1 Drive motor nameplate
- 2 Drive motor production number mark

Location of power battery code

The power battery is installed at the bottom of the vehicle, and CATL's battery pack label information is pasted on the rear part of the battery pack.

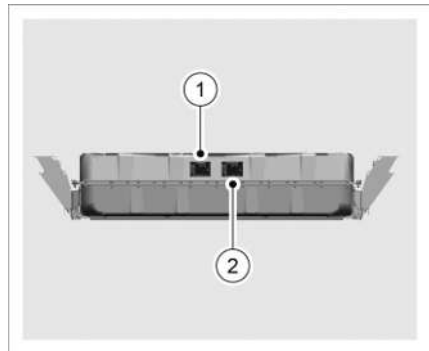

- 1 Power battery pack nameplate
- 2 Power battery system nameplate

Microwave window

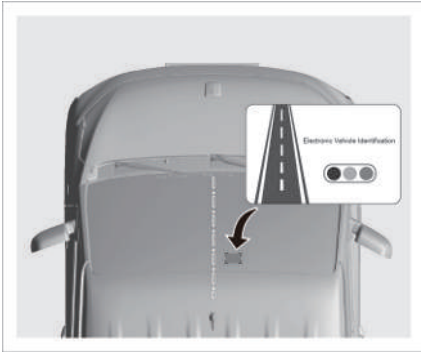

The microwave window of the vehicle is located on the upper right side in the middle of the front windshield.

The vehicle electronic identification shall not be blocked by other mounting components, such as ETC device and sensor bracket.

This sign stores information about the vehicle.

 Please keep the windshield clean and dry; do not film or stick metal materials on the microwave window, so as to ensure the standard installation of automobile electronic signs and effective reading of data.

Please do not block, squeeze or disassemble the automobile electronic signs!

If the sign is damaged, please apply again at the sign issuing agency in time. ◀

Vehicle nameplate

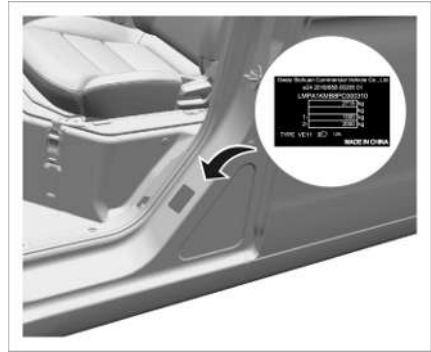

The vehicle nameplate is located at the front door sill of B-pillar on the left side of the cab and contains the following information:

- Name of manufacturer
- Certification No.
- VIN code
- Maximum allowable total mass
- Allowable combined mass
- Axle load of axle 1
- Axle load of axle 2
- Vehicle model
- Dip angle of low beam

Vehicle overview

Front view

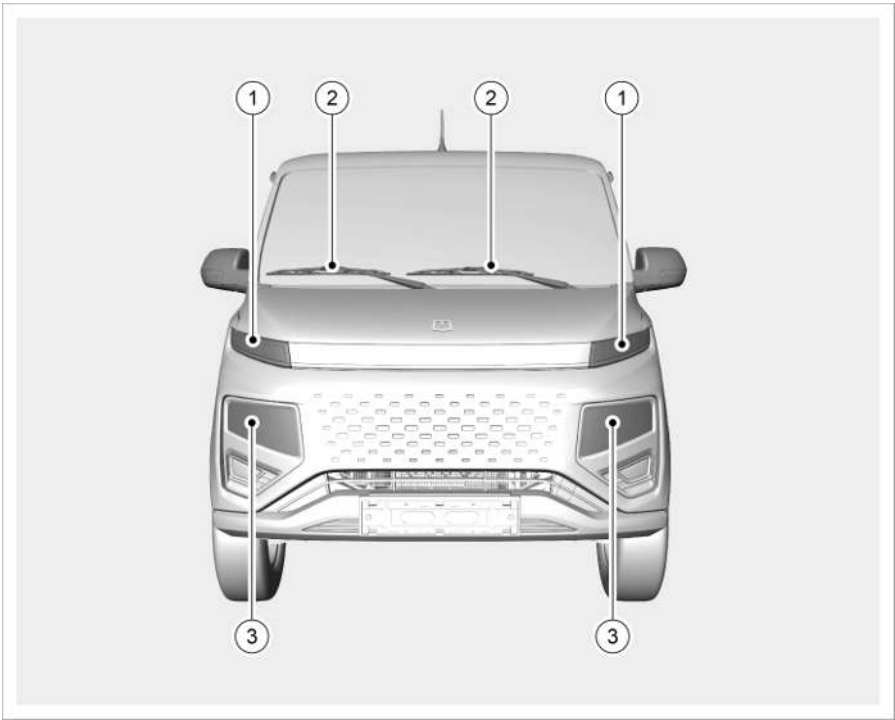

- 1 Front daytime running lamp
- 2 Front wiper
- 3 Front combination lamp (high beam, low beam and turn signal)

Side view

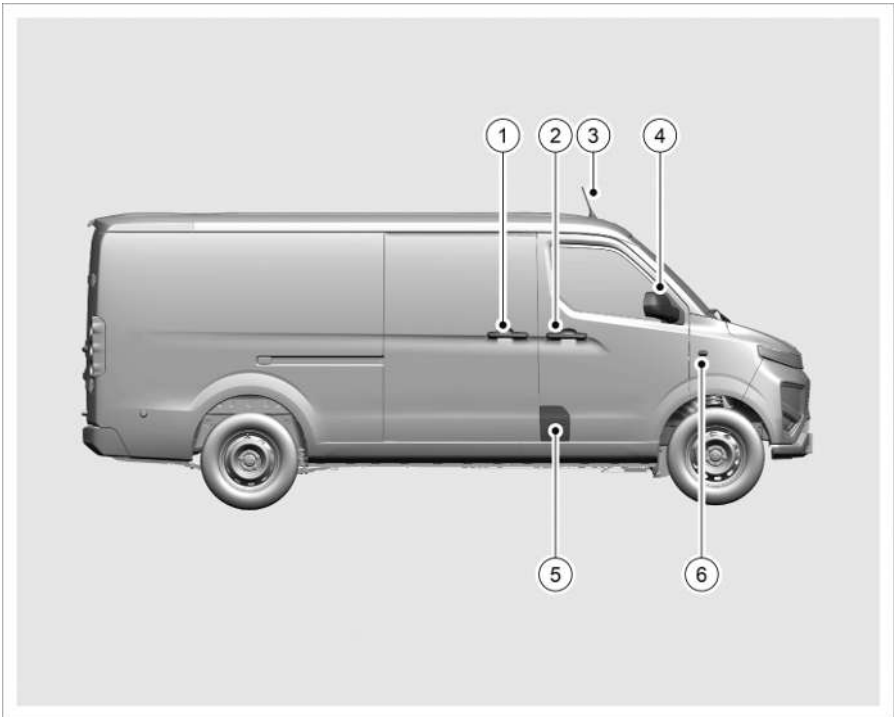

- | | |
|--|------------------------------|
| 1 Exterior handle of side sliding door | 4 Exterior rearview mirror |
| 2 Front door exterior handle | 5 Cover plate, charging port |
| 3 Radio antenna | 6 Side turn signal |

Rear view

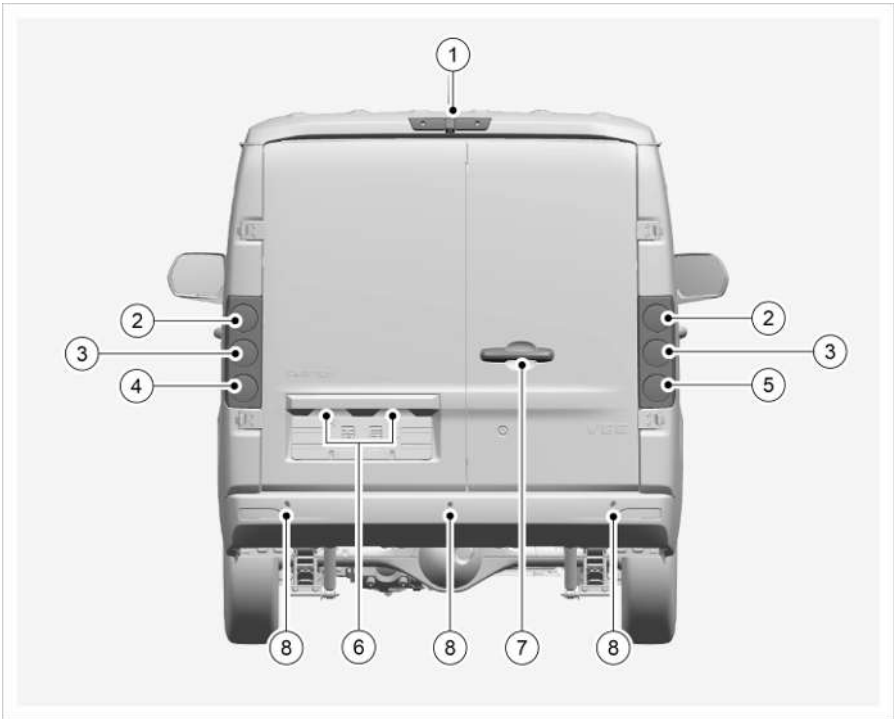

- | | |
|--|-------------------------------|
| 1 High-mounted brake lamp and reversing camera | 5 Rear fog lamp |
| 2 Brake lamp & position lamp | 6 License plate lamp |
| 3 Turn signal | 7 Exterior handle of tailgate |
| 4 Reversing lamp | 8 Reversing sensor |

Introduction to the system

Overview

Location diagram of HV system

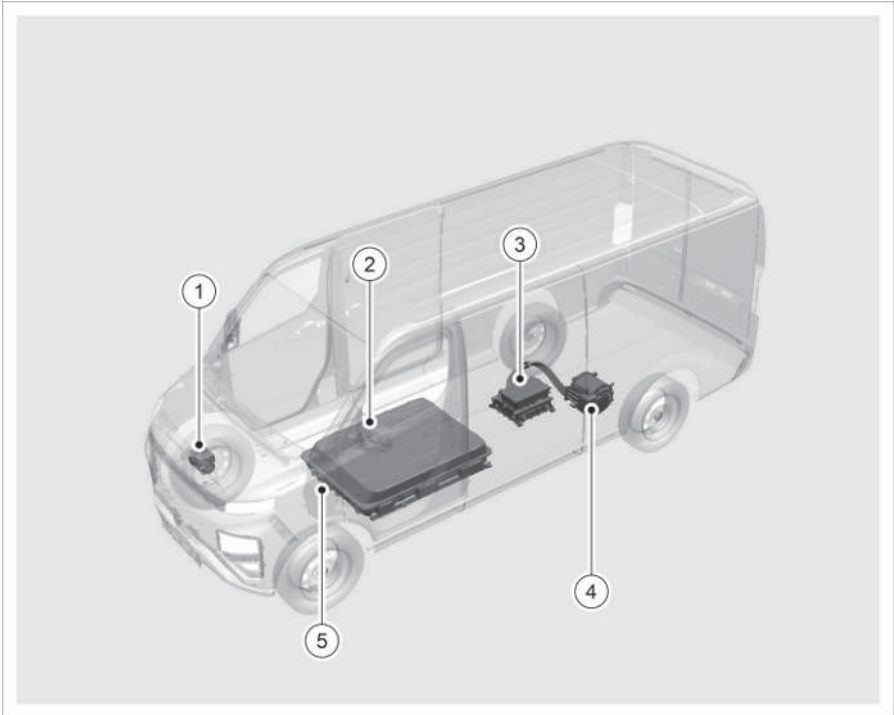

- | | |
|--|---------------|
| 1 Electric compressor | 4 Drive motor |
| 2 Power battery | 5 MSD |
| 3 HV main and auxiliary drive controller | |

HV safety

The pure electric powertrain, HV parts and cables of this vehicle are equipped with electromagnetic shielding devices. The amount of electromagnetic wave emitted by the electromagnetic shielding devices is almost the same as that of conventional gasoline-powered vehicles or household appliances. The electromagnetic wave will not cause damage to human body.



The electric energy is used as the power source of this vehicle, and the power battery provides HV DC for the HV electrical system. The power battery is converted into three-phase AC by the motor controller to supply power to the drive motor. In order to ensure the personal safety of passengers and first-aid personnel, please pay attention to the following matters:

- There is a HV fuse in the power battery to provide short-circuit protection for the power battery.
- The positive and negative HV cables connected to the power battery are usually controlled by the LV normally open relay. When the vehicle LV power supply is disconnected, the relay can be disconnected to prevent

HV current from flowing out of the power battery.

- Orange HV warning labels are affixed to some parts of the vehicle to warn that there is HV in this part. Always observe the contents of the HV label.
- The voltage can only be reduced to safe voltage for human touch 15 minutes after the vehicle power supply is cut off. To prevent serious injury or even death due to severe burns or electric shock, do not touch, cut off or damage any orange HV cables or HV components.
- Non-professional service personnel are not allowed to touch, disassemble or install any parts of the HV system, such as drive motor, motor controller, A/C compressor and power battery.
- When the vehicle is running, its control system will always monitor whether there is HV leakage. If a malfunction is detected, the malfunction indicator on the instrument cluster will illuminate. ◀

Power cut-off device of power battery

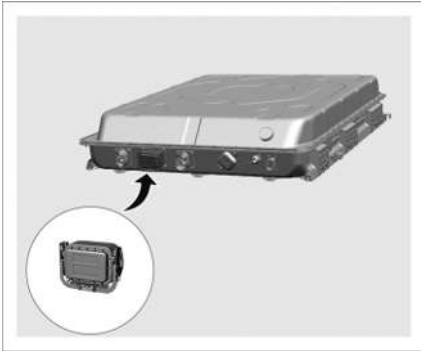

The manual service disconnect (MSD) of the power battery is located at the front end of the power battery pack at the bottom of the vehicle. After the MSD switch is removed, the power output of the power battery can be cut off. Should there be a need to disconnect the MSD device, please contact a Farizon Auto after-sales service station and do not operate it personally.

The vehicle has the function of vehicle collision power-off. When the collision sensor detects a certain degree of collision, it will urgently cut off the system and HV current output to minimize the risk of electric shock. Once the emergency cut-off system is activated, the vehicle cannot be restarted the usual way. Please contact the Farizon Auto after-sales service station for maintenance and help in restarting the vehicle.

Warning information

When the system fails or the user does not operate properly, relevant warning lamps on the instrument cluster will light up automatically. If the instrument cluster illuminates the LV battery warning lamp or relevant indicators of HV system, the vehicle may not be started at this time. Please contact a Farizon Auto after-sales service station for troubleshooting.

 When the vehicle fails, contact a Farizon Auto after-sales service station in time for maintenance.

This vehicle is equipped with a HV DC system. Do not overhaul the vehicle by yourself in case of any fault. Accidental touching of HV may cause electric shock injury or even death. Non-professionals are not allowed to touch, move or disassemble the power battery and corresponding HV cables or other components with HV warning signs; otherwise, electric shock injury or even death may be caused due to improper operation. Unauthorized maintenance personnel are strictly prohibited from disassembling and assembling the power battery and related HV components, otherwise electric shock injury or even death may be caused due to improper operation. ◀

Maintenance, repair, recycling and scrapping

As one of the main power sources, the power battery can be charged repeatedly. The power battery can be charged through AC/DC charging piles that meet the national standards. When the vehicle is braking, it can also recycle braking energy and charge the power battery through a motor.

- For a new vehicle, under the normal status of power battery, its driving range will fluctuate because of different driving habits (e.g. frequent acceleration or deceleration), road conditions (e.g. climbing up long and steep slopes), temperature (e.g. low temperature) and the turning on/off of electrical equipment (e.g. air conditioner).
- The power battery is a special chemical product, which needs to be used and maintained correctly. It does not suffer from loss of electricity in daily life. Being fully charged rather than fully discharged is very critical for its performance maintenance. In addition, the power battery capacity is subject to natural attenuation due to its chemical properties. Therefore, for vehicles that have been used for a period of time, when it is found that the vehicle is fully charged and the endurance mileage reduces, it is

recommended to drive to the Farizon Auto after-sales service station for inspection. If the Farizon Auto after-sales service station checks and finds that the total power charging capacity of the power battery is within the normal range, the reduction of endurance mileage is caused by external factors such as driving habits and temperature.



To keep the power battery in its best service status, fully charge the power battery with charging equipment at regular intervals (full charging at least once a week is recommended).

If the storage time exceeds three months, the power battery must be charged; otherwise, it may cause over-discharge of the power battery and reduce its performance. Warranty will not be provided for the vehicle faults and damages caused thereby. ◀

Precautions for use of power battery

Power battery is a HV energy storage device and belongs to dangerous goods. Improper operation and use by non-professionals may cause serious consequences such as electric shock, burning and explosion.

The installation and maintenance of power battery must be operated by professional technicians of a Farizon Auto after-sales service station, and

relevant safety regulations must be strictly observed during use. It is strictly forbidden for non-professionals to install, repair and use power batteries beyond the specified scope. No warranty will be given for battery damage and other losses caused by use in violation of the specified requirements or use beyond the specified scope. The following points shall be noted:

1. **Moisture and water prevention**
The power battery is a HV energy storage device and contains many HV control circuits and battery cells. Liquid entering the power battery may cause short circuit, leakage, and corrosion of battery cells, electronic circuits and connectors. Therefore, it is necessary to ensure that the power battery will not be soaked by various liquids and humid air will not enter it.
2. **Environmental Insulation**
Keeping the power battery working within the optimal operating temperature range can greatly prolong its service life and improve its safety performance. Therefore, the surrounding area should be insulated and ventilated when the vehicle is parked.
3. **Shock and collision prevention**
The internal batteries of the power battery are connected in series and equipped with a management system and various

sensing devices. Please be careful when driving on uneven roads to prevent the power battery from bumping.



It is forbidden to modify parts and components of the pure electric powertrain or install electronic products that do not meet national requirements around them, otherwise the performance and service life of the pure electric powertrain may be affected. ◀

Power battery recycling process

Users can only hand over used power batteries to the recycling service stations designated by a Farizon Auto after-sales service station or contact local environmental protection departments and government agencies, and shall not hand them over to other departments or individuals.

The vehicle owner shall bear full responsibility for environmental pollution or safety accidents caused by unauthorized removal and disassembly of the power battery.

The power battery shall be repaired, disassembled and replaced by professionals. Unauthorized personnel are strictly prohibited from disassembling and the assembling power battery and related HV components.



Never sell, transfer or modify the power battery. The power

battery shall be recycled by a designated Farizon Auto after-sales service station according to the specified process. Remove the power battery from the scrapped vehicle to prevent safety accidents.

Unauthorized maintenance personnel are strictly prohibited from disassembling and assembling the power battery and related HV components, otherwise electric shock injury or even death may be caused due to improper operation.

Non-professionals are not allowed to touch, move or disassemble the power battery and corresponding HV cables or other components with HV warning signs; otherwise, electric shock injury or even death may be caused due to improper operation. ◀

Charging system

Precautions for charging



Be sure to observe the following precautions to avoid HV electric shock or more serious injury:

- Charging operation will have the following impacts on certain people: During fast charging, electromagnetic field interference may be generated in the operation area. It is recommended that users with implanted cardiac

pacemakers and implanted cardiovascular defibrillators stay away from vehicles during charging operations. Electromagnetic field interference may affect the normal efficacy of medical electronic devices, such as implanted cardiac pacemakers and implanted cardiovascular defibrillators. This may result in injury or death to the user carrying the above-mentioned electronic medical devices. If you carry an implanted cardiac pacemaker or implanted cardiovascular defibrillator, please do not stay in the vehicle for a long time or enter the vehicle during charging.

- Before charging, please make sure to dry the rain and stains near the charging port of the vehicle body before opening it. Pay special attention not to leave residual water stains on the charging socket and its surrounding area.
- It is forbidden to touch the metal parts of charging interface and charging plug when the vehicle is being charged. If the vehicle or on-board charger has an electric spark, it is forbidden to touch the electric vehicle and any parts; otherwise, an electric

shock and personal injury will occur.

- It is recommended that the ambient temperature during vehicle charging ranges from 0 °C to 40 °C, and avoid charging at a low temperature or high temperature. It is recommended to charge at noon in winter and in the morning and evening in summer.
- During charging, make sure that the charging cable is in a natural status. Do not hang it in the air or wind it with other objects.
- If you find special smell or smoke in the vehicle, please cut off the power supply immediately and safely.
- It is forbidden to plug and unplug the charging plug with wet hands and standing in a place with water, liquid and snow; otherwise, it is easy to cause electric shock and casualties.
- When unplugging the charging plug, please hold the insulating part of the plug and do not drag or pull the charging cable directly.
- After charging, please make sure to close the protective cover of the charging socket

and the cover plate of the charging port. Please confirm that the charging plug has been pulled out from the charging port before starting the vehicle.

- The vehicle contains a set of sealed HV lithium-ion power batteries. If the power battery is improperly exposed, there will be a danger of severe burning and electric shock, which may lead to serious casualties and environmental pollution.
- Children are prohibited from charging. The charging plug is HV electrical equipment. Children are prohibited from using it.
- Please make sure that the charging interface and plug are free of water or other foreign matters, rust or corrosion. If there is water or rust on the charging interface or plug, please do not charge, so as to avoid short circuit or electric shock, or casualties.
- Please keep the power equipment, vehicles to be charged, charging cables and charging plugs away from rain, snow, accumulated water and heat source.
- Before charging, please check whether the surface and shell of charging cable are

- damaged. If the above situation occurs, please contact a Farizon Auto after-sales service station for repair or replacement. It is forbidden to use damaged charging cables.
- It is forbidden to disassemble or modify the charging port without permission.
 - It is forbidden to extend or modify the charging cable or plug without permission; otherwise danger will easily occur.
 - There may be sparks inside the charging system when it is working. Please select a dry and ventilated charging environment, and do not use charging equipment in an environment where explosive materials such as gasoline and paint are stored.
 - In case of sudden weather changes (wind, rain and snow, thunderstorm) during charging, check in time, whether the charging plug is firm and dry. Do not touch the charging cable and vehicle body when lightning occurs.
 - Do not squeeze the charging cable during charging, so as to avoid electric shock or fire.
- Do not put the charging cable in the vehicle during charging.
 - The charging cable must be kept away from fire during charging.
 - Do not approach or touch the cooling fan during charging.
 - Please use nationally certified charging pile equipment during charging.
 - When the domestic power supply is used for charging, the AC specifications of the selected socket and patch cord should not be lower than the rated current on the nameplate of AC charging socket. ◀

Charging interface

Location of charging interface

The charging interface is located at the lower left of the right front door.

Open the cover plate of the charging port with a key to access the charging interface.

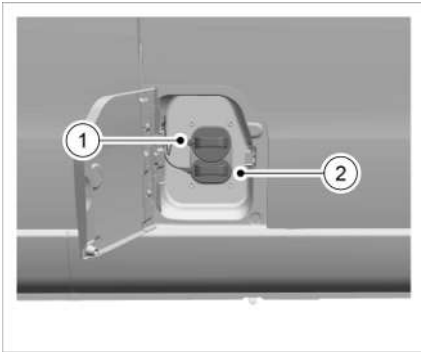

- 1 Slow charging port
- 2 Fast charging port

Charging operation

DC fast charging with charging pile

1. Turn the start switch to "OFF" position and pull up the parking brake.
2. Turn the key clockwise to open the cover plate of the charging port.
3. Open the dust cover A of slow charging port and then the dust cover B of fast charging port.
4. Unlock the charging plug on the DC charging pile and insert it into the fast charging socket of the vehicle body (please do not press the locking button of the charging socket) until a "click" sound is heard and the locking button of the vehicle charging socket bounces, indicating that the vehicle charging connection is good. The charging connection indicator  on the instrument cluster will illuminate.

 Make sure that the charging plug is fully inserted into the charging port to avoid locking failure of the electronic lock, resulting in charging failure. ◀

1. Please read the precautions and other information on the DC charging pile carefully, and follow the regulations. After a series of operations such as swiping the card or scanning QR code and starting with mobile app, the charging pile starts DC charging. During charging, the charging

indicator  on the instrument will illuminate. After the battery is fully charged, the system will automatically stop charging and this indicator will go out.

 The charging must be carried out or stopped in strict accordance with the operation procedure of charging pile. It is forbidden to plug and unplug the charging socket during charging. ◀

 Please use fast charging equipment that meets the standard; otherwise it may cause failure or fire, resulting in casualties. ◀

1. After charging is completed, turn off the charging procedure. Unlock the DC charging plug, pull it out of the charging port on the vehicle and place it at the designated position of the charging pile.

2. Close the vehicle charging port dust cover.
3. Close and lock the cover plate of the charging port.

AC slow charging with charging pile

1. Turn the start switch to "OFF" position and pull up the parking brake.
2. Turn the key clockwise to open the cover plate of the charging port.
3. Open the lock catch of the slow charging port dust cover and open the slow charging port dust cover.
4. Insert the AC charging plug into the vehicle socket (please do not press the locking button) until a "click" sound is heard and the locking button of the vehicle charging socket bounces, indicating that the vehicle charging connection is good.

After the charging plug is connected, the charging connection signal indicator  on the instrument cluster will illuminate.

5. Please read the precautions and other information on the AC charging pile carefully, and follow the regulations.

After a series of operations such as swiping the card or scanning QR code and starting with mobile app, AC charging starts. When the vehicle is being charged, the

charging indicator  on the instrument cluster will illuminate. After the battery is fully charged, the system will automatically stop charging and this indicator will go out.



The charging must be carried out or stopped in strict accordance with the operation procedure of charging pile. It is forbidden to plug and unplug the charging socket during charging. ◀

1. After charging is completed, turn off the charging procedure. Press the charging plug unlock button to pull out the charging plug from the vehicle charging port and place it at the designated position of the charging pile.
2. Close the vehicle charging port dust cover.
3. Close and lock the cover plate of the charging port.

Household AC slow charging



Pay attention to the following items when charging with domestic power supply to avoid HV electric shock or more serious injury:

- AC specifications of the selected socket and patch cord should not be lower than the rated current on the nameplate of AC charging socket.

- It is necessary to ensure that the socket of household power supply is grounded reliably; otherwise, there is danger of electric shock.
- The socket should be a special charging socket with circuit break protection function to avoid line damage or trip caused by high-power charging which will affect the normal use of other equipment. ◀

 Before using the household AC slow charging equipment, please read the instructions carefully and charge it in strict accordance with the instructions. ◀

1. Turn the start switch to "OFF" position and pull up the parking brake.
2. Turn the key clockwise to open the cover plate of the charging port.
3. Open the lock catch of the slow charging port dust cover and open the slow charging port dust cover.
4. Take out the household AC charging equipment. Insert the plug into the EV socket, and then the power indicator of the charging equipment will illuminate.

 Please use a socket that meets the electric standard of charging plug; otherwise, it may cause

heating or even short circuit of household circuits and lead to fire. ◀

1. Insert the AC charging plug into the vehicle socket (please do not press the locking button) until a "click" sound is heard and the locking button of the vehicle charging socket bounces, indicating that the vehicle charging connection is good. After the charging plug is connected, the charging connection signal indicator  on the instrument cluster will illuminate.

 When plugging and unplugging the charging socket, please hold the insulating part of the socket and do not drag or pull the charging cable directly. Do not squeeze the charging cable with the doors, windows and wheels during charging. ◀

1. After the self-inspection is passed, the charging indicator of the charging cable control box flashes and charging starts. The charging indicator  on the instrument cluster will illuminate. After the battery is fully charged, the system will automatically stop charging and this indicator will go out.

 When the fault indicator of household AC charging cable control box illuminates, please confirm whether the charging

plug is well connected with the vehicle charging port and operate according to the instructions provided. ◀

1. Unplug the EV socket after vehicle charging is completed.
2. Press the charging plug unlock button to pull out the charging plug from the charging port on the vehicle.
3. Close the vehicle charging port dust cover.
4. Close and lock the cover plate of the charging port, and store the household AC charging equipment.

 For different charging equipment, the charging power and the charging time will also vary. In addition, the charging operation time is also affected by ambient temperature. If the communication protocol of charging equipment does not meet the national standards, charging will fail. ◀

Emergency unlocking of charging plug

If the charging plug cannot be unlocked normally after the vehicle charging is completed, please operate according to the following steps.

1. Lift up the front passenger seat. For specific operation, please refer to “Seat” [▶ 54] chapter to lift the seat.

2. Pull the emergency unlocking switch in the direction of the arrow and pull out the charging plug.



- When the charging plug or charging pile indicator shows abnormality during charging, please pull out the on-board charging plug and reinsert it into the charging base.
- If the charging plug still cannot be unlocked after performing the emergency unlocking steps of the charging plug, please contact the charging equipment manufacturer or a Farizon Auto after-sales service station for help.
- It is strictly prohibited to use brute force to insert and pull out the charging plug by yourself. ◀

Instruments and controls

Cockpit overview

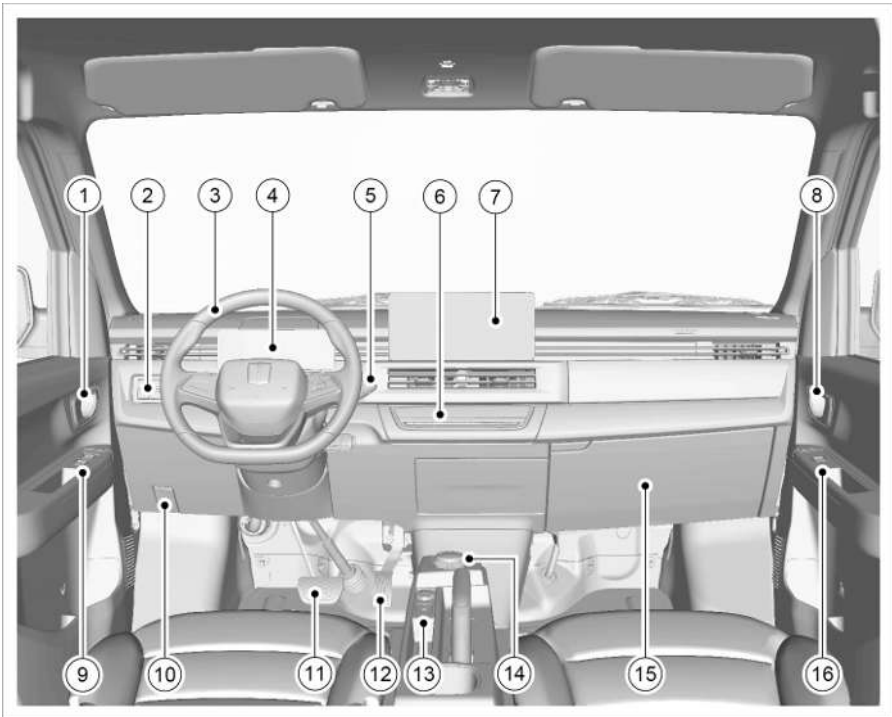

- | | |
|---------------------------------------|----------------------------------|
| 1 Interior handle of driver's door | 9 Driver door combination switch |
| 2 Instrument panel switch group | 10 Hood opening lever |
| 3 Steering wheel | 11 Brake pedal |
| 4 Instrument cluster | 12 Accelerator pedal |
| 5 Multi-function switch | 13 USB/power interface |
| 6 A/C control panel | 14 Gearshift knob |
| 7 Central control screen | 15 Glove Box |
| 8 Interior handle at passenger's side | 16 Passenger side window switch |

Instrument cluster

Overview of instrument cluster

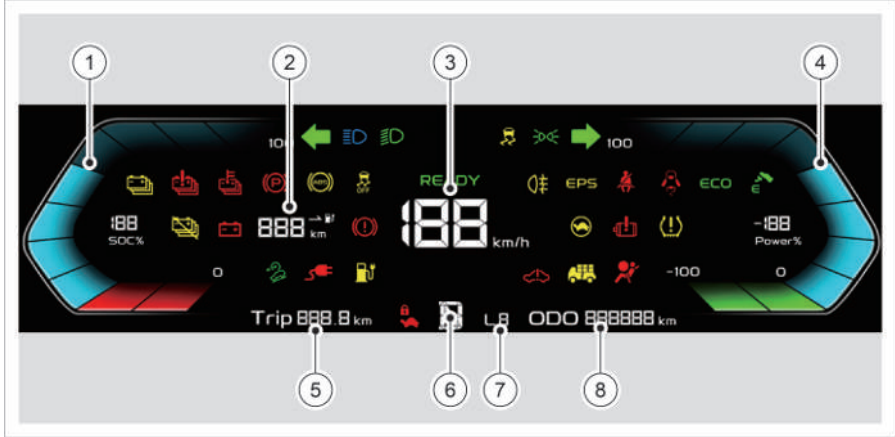

- | | |
|-----------------|-------------------------|
| 1 SOC indicator | 5 Trip mileage |
| 2 Driving range | 6 Gear |
| 3 Vehicle speed | 7 Energy recovery level |
| 4 Power meter | 8 Total mileage |

Driving gauges

SOC indicator

When the start switch is turned to “ON”, the SOC indicator will display the current remaining SOC of the power battery.

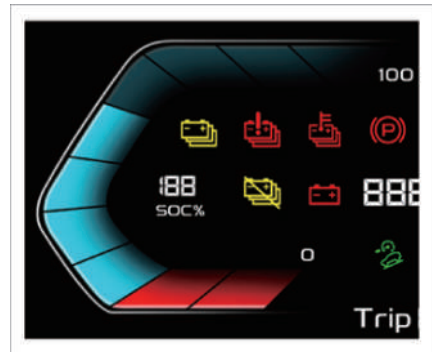

The upper limit of the SOC indicator is 100%, and the lower limit is 0. There are 10 grids in total; the upper 8 grids are displayed in blue, and the

lower 2 grids are displayed in red. When the SOC of the power battery is less than 20%, the SOC indication will turn red and the low SOC indicator will be on. Please charge it in time.

 When the battery level is lower than 7%, the vehicle will limit its power output. At this time, both the maximum driving speed and acceleration time of the vehicle are limited.

When the battery level is lower than 2%, please stop driving and charge the vehicle immediately.



Power meter

The power meter is used to display the instantaneous output power of the vehicle's current drive motor.

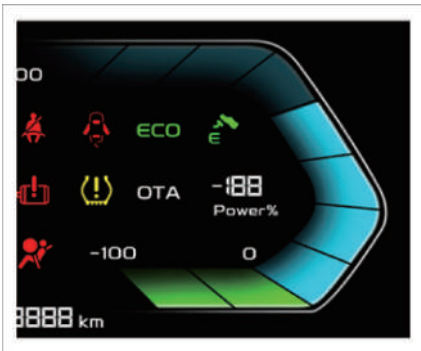



The upper limit of the power meter is 100%, and the lower limit is -100%. There are 10 cells in total; the upper 8 cells are displayed in blue, indicating power output; the lower 2 cells are displayed in green, indicating energy recovery. At this time, the value is displayed as negative.

Common Information

Display information of the instrument cluster includes driving range, trip mileage, total mileage, recovered energy level and gear information.



 For safety reasons, it is prohibited to adjust the instrument cluster display during driving. 

Driving range

It indicates the mileage that the vehicle can be driven based on the current remaining SOC. Due to different road conditions and driving status, the displayed driving range will be different from the actual driving distance, and the value is only for reference.

The driving range has two display modes: standard mode and dynamic mode. The default mode is the standard mode. Tap **Vehicle Settings-Endurance Mode Switching** on the central control screen menu to turn on the dynamic mode.



In the standard mode, the driving range is calculated based on the overall average energy consumption of the vehicle; in the dynamic mode, the driving range is calculated based on the dynamic energy consumption output by current driving habits. The driving range displayed in this mode is relatively close to the actual driving range.

Trip mileage

It displays the single mileage of the vehicle. When the vehicle is stationary, press and hold the "RESET" button on the top of the light control lever for about 3s to reset the trip mileage.

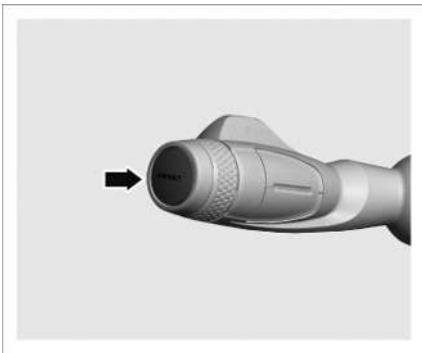

Total mileage

Display the accumulated mileage of the vehicle.

Energy recovery level

It displays the currently set energy recovery level, and can be set by pressing the energy recovery button of instrument panel left switch group.

Shift information















The gear information will be displayed in real time at the middle and lower parts of the instrument cluster. In case of gearshift operation error, the current gear will flash 3 times with a prompt tone.

Warning lamps and indicators

















Information of warning lamps and indicators

The current status information of the vehicle is displayed through the warning lamps and indicators on the instrument cluster, so that the driver is aware of the vehicle status. When the vehicle is started, the system will

carry out self-inspection. Some indicator lamps will light up for a period of time and then go out or go out after the vehicle is started. Warning lamps and indicators indicate the working state of corresponding functions or possible system faults. Some warning lamps and indicators will be accompanied by audible signals and message reminders when they appear.

S/N	Description	Image	Color
1	Left turn signal indicator		Green
2	Right turn signal indicator		Green
3	High beam indicator		Blue
4	Position lamp indicator		Green
5	Low beam indicator		Green
6	Rear fog lamp Indicator		Yellow
7	Brake system malfunction indicator		Red
8	Parking indicator		Red
9	Warning lamp of Anti-lock Brake System (ABS)		Yellow
10	Seat belt reminder		Red
11	Electronic stability control (ESC) indicator		Yellow
12	ESC OFF indicator		Yellow
13	Charging cable connection indicator		Red
14	Charging state indicator		Yellow

Instrument and control

S/N	Description	Image	Color
15	Powertrain malfunction indicator		Red
16	Power limit indicator		Yellow
17	Power battery cut-off warning lamp		Yellow
18	READY indicator		Green
19	Drive motor malfunction indicator		Red
20	Power battery malfunction indicator		Red
21	Power battery SOC low indicator		Yellow
22	Door ajar warning lamp		Red
23	ECO mode indicator		Green
24	Hazard warning lamp		Green
25	Electronic steering system (EPS) fault indicator		Yellow
26	Power battery overtemperature alarm indicator		Red
27	Airbag malfunction indicator		Red
28	Battery charging fault warning indicator		Red
29	POWER indicator		Green
30	TPMS indicator		Yellow
31	HDC indicator		Green/ Yellow

Introduction to warning lamps and indicators

Left turn signal indicator - green

When the left turn signal is turned on, the left turn signal indicator and the left turn signal will light up simultaneously.

Right turn signal indicator - green

When the right turn signal is turned on, the right turn signal indicator and the right turn signal will light up simultaneously.

 If the indicator flashes at a frequency faster than the normal state, it means that the external turn signal on the same side is faulty. Please contact a Farizon Auto after-sales service station for maintenance as soon as possible. ◀

Low beam indicator - green

When the light combination switch is turned to the low beam, the indicator illuminates.

High beam indicator - blue

When the high beam is turned on, the indicator will illuminate.

Position lamp indicator - green

When the position lamp is turned on, the indicator will illuminate.

Brake system malfunction indicator - red

When the start switch is turned to ON position or the vehicle starts, this warning lamp will light up for several seconds for self-inspection and then go out if the system works normally. If the warning lamp keeps on, it indicates that the brake fluid level is too low or there are other faults in the braking system. Please contact the Farizon Auto after-sales service station for maintenance as soon as possible.

 If the brake system malfunction indicator is on, the brake system may not function normally. Driving while the brake system malfunction indicator is on may result in a collision. If the vehicle leaves the road and stops carefully, please contact a Farizon Auto after-sales service station for maintenance as soon as possible. ◀

Parking indicator - red

When the parking brake is applied, this indicator will illuminate. After the parking brake is released, the indicator will go out.

Anti-lock brake system (ABS) warning lamp - yellow

When the start switch is turned to ON position, the warning lamp will light up for several seconds for self-inspection. If the ABS and Brake

Assist System (BAS) function normally, the warning lamp will go out; if the system breaks down when the vehicle is started or running, the warning lamp will be on. Please contact a Farizon Auto after-sales service station for maintenance as soon as possible.

 If the warning lamp turns on and off during driving, and it does not turn on again, the system can be deemed as normal. If the ABS malfunction indicator stays on, pull over the vehicle in a safe place immediately and contact a Farizon Auto after-sales service station for maintenance as soon as possible. In case of braking under such circumstance, not only ABS will fail, but also the vehicle will become unstable at the time of braking. ◀

Unfastened seat belt warning lamp - red

When the start switch is turned to ON position, if the driver's seat belt or passenger's belt is not fastened, the warning lamp will stay on. The warning lamp goes out after the driver or the passenger has correctly fastened the seat belt.

Electronic stability control (ESC) indicator - yellow

The indicator flashes when the ESC system works. If the ESC system fails and the indicator lamp is always on,

please contact a Farizon Auto after-sales service station for maintenance as soon as possible.



ESC OFF indicator - yellow

When the ESC system is turned off, the indicator will be on. When the ESC system is turned on again, this indicator will go out.

Charging cable connection indicator - red

This indicator is used to indicate the connection status of the charging cable. When the charging cable is connected, this indicator lights up. The vehicle cannot start or move when the charger is connected.



Charging status indicator - yellow

If this indicator is on, it indicates that the power battery is being charged.



Powertrain malfunction indicator - red

When the vehicle control system fails, the warning lamp will be on. Please contact a Farizon Auto after-sales service station for maintenance as soon as possible.



Power limit indicator - yellow

When some specific faults occur in the vehicle, the power of the vehicle will be limited. This indicator is used to show the power limit status. If the indicator is on, the acceleration

performance of the vehicle will be greatly reduced.



Power battery cut-off warning lamp - yellow

When the power battery of vehicle is disconnected, the indicator is on. At this time, the input voltage of the motor controller is zero and the vehicle cannot run. Please contact a Farizon Auto after-sales service station for maintenance as soon as possible.



READY indicator - green

This indicator lights up when the vehicle is ready and can run normally. If the READY light is not on, which indicates that there is a fault in the vehicle or other conditions are not met. The vehicle is not fully ready and cannot run normally.



Drive motor malfunction indicator - red

This warning lamp indicates the fault of drive motor (and motor controller). It will be on when drive motor (and motor controller) fails. Please contact a Farizon Auto after-sales service station for maintenance as soon as possible.



Power battery malfunction indicator - red

This warning lamp indicates whether the power battery fails. If it fails, this warning lamp will be on. Please contact a Farizon Auto after-sales

service station for maintenance as soon as possible.



Low power battery indicator - yellow

When the remaining power of the power battery is lower than 20%, this indicator will light up. Please charge the vehicle in time.



Door ajar warning lamp - red

When any door is not closed properly, the indicator will be on to remind the driver to close the door.



Economic mode (ECO) indicator - green

When the ECO switch is pressed, the vehicle will enter ECO mode and this indicator lights up. In this mode, the power of the vehicle is relatively gentle, which is conducive to saving electricity and obtaining the maximum driving range.



Hazard warning lamp - green

When the hazard warning lamp switch is enabled, the left and right turn signals will flash synchronously with those on the instrument cluster.



Electronic power steering (EPS) fault indicator - yellow

When the electronic steering system (EPS) fails, this indicator will light up. Please contact a Farizon Auto after-sales service station for maintenance as soon as possible.



Power battery overtemperature alarm indicator - red

When the power battery temperature is too high, this indicator will light up. Please contact a Farizon Auto after-sales service station for maintenance as soon as possible.



Airbag malfunction indicator - red

When the airbag system is faulty, this indicator lamp will light up. Please contact a Farizon Auto after-sales service station for maintenance as soon as possible.



Battery charging malfunction indicator - red

After the low-voltage battery fails to be charged, this indicator will light up. Please contact a Farizon Auto after-sales service station for maintenance as soon as possible.



POWER mode indicator - green

After the POWER mode function is enabled, this indicator will illuminate.



TPMS indicator - yellow

When the TPMS detects a flat tire, this indicator stays on. When the TPMS indicator flashes for about 1 minute and then lights up, it indicates that there is a fault in the system. Please contact a Farizon Auto after-sales service station for maintenance.



HDC indicator - green/ yellow

When the HDC function is enabled, the green indicator on the instrument cluster will light up. When the HDC function fails, the yellow indicator on the instrument cluster will light up. Please contact a Farizon Auto after-sales service station for maintenance.

Light control

Operation of light control combination switch

Position lamp



Rotate the control switch at the top of the light operating lever to adjust the

gear to the  position, and then all the position lamps and interior backlights will be on. Return to the OFF position, and turn off all position lamps and interior backlights.

Low beam



Adjust the gear to the position  at the top of the rotating light control lever, and the low beam lights will turn on.

Automatic headlights



Turn the rotary control switch at the top of the light operating lever to AUTO position, and turn on the automatic lighting function of the headlamp. The automatic lighting system automatically controls the turning on and off of the headlamp according to the external light intensity. When the external environment is dark to a certain

extent due to darkness or entering tunnels, the position lamp and low beam will be automatically turned on. When the external environment returns to a certain brightness, the position lamp and low beam will automatically turn off after a few seconds.

High beam

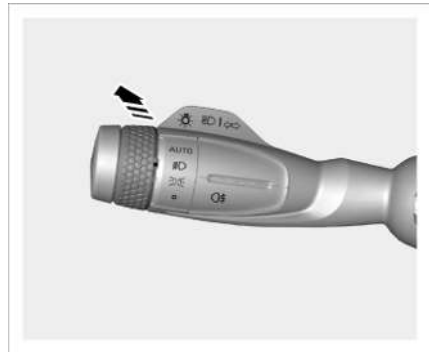

With the low beam ON, push the light lever away from your body to turn on the high beam. Reset the operating lever and switch back to low beam.

High beam flashing



Pull the operating lever towards your body to turn on the high beam. After the handle is released, the operating

lever will automatically reset and the high beam lamps will automatically turn off. Repeatedly operate the high beam flashing to remind other road users.

 Use the high beam reasonably. Unreasonable use of high beams may affect the sight of other traffic participants and cause dazzle, which may lead to accidents or serious injuries.

The use of high beams is prohibited in some road sections. Please pay attention to the traffic regulations when using high beams. ◀

Turn signal

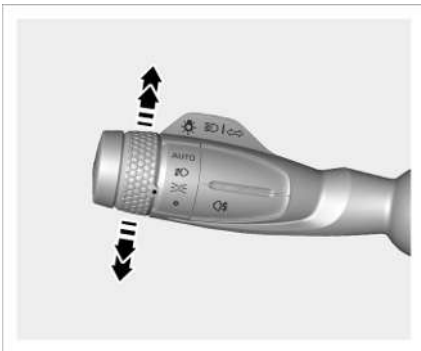

Pull the operating lever up and down to the limit position, turn on the right or left turn signal lamp, and the corresponding turn signal lamp flashes continuously.

Lane change lamp function: Pull the control lever up and down for a short distance to the middle position, and the right or left turn signal will flash. After releasing it, the handle will

automatically return to its original position.

 The steering lamp operating lever has an automatic reset function. If the angle of the steering wheel is too small, it needs to be manually reset. ◀

Daytime running lamp

When the vehicle power supply is in "ON" mode, the daytime running lamps will be automatically turned on; when the low beam lamps are turned on, they will be automatically turned off. After the low beam is turned off, the daytime running lamp will be automatically turned on.

Rear fog lamp

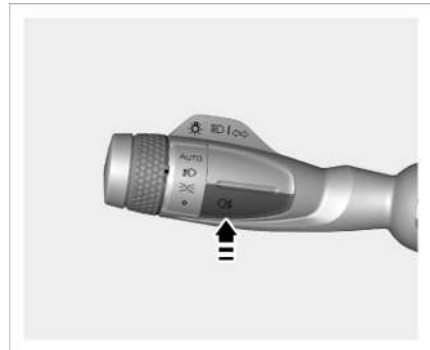

With the low beam ON, press this switch to turn on or turn off the rear fog lamp .

Follow me home

After the "Follow Me Home" function is enabled, the headlamp will light up and go out for a period of time when the vehicle power supply is turned off. Tap **Vehicle Settings - Follow Me**

Home on the central control screen menu to enable the function and set the duration.



The "Follow Me Home" function time can be set to 30 seconds, 60 seconds or 90 seconds.

Headlamp height adjustment

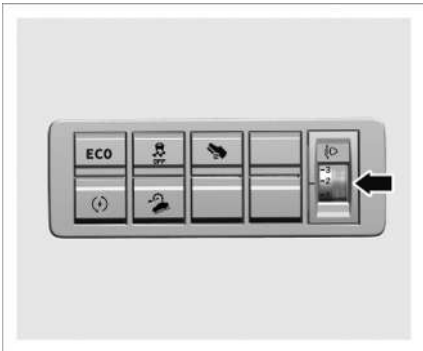

The knob is used to adjust the irradiation height of the front combination lamp. The front combination lamp height adjustment knob has four positions: "0", "1", "2" and "3".

i It is recommended to set the knob position according to the vehicle load state:

Gear 0: There are people in front of the car, and the cargo compartment is empty;

Gear 1: The vehicle is full and the cargo compartment is empty;

Gear 2: The vehicle and its cargo compartment are full;

Gear 3: There is only the driver in the vehicle, and the cargo compartment is full. ◀

Wiper and washer

Wiper control combination switch

Operation of wiper control combination switch

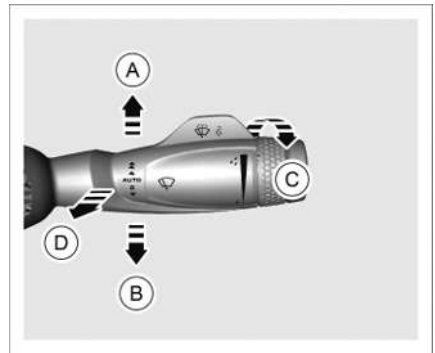

Wiper inching wiping

Pull the wiper control handle towards direction B and release it. The wiper control handle will automatically return to "0" gear, and the front wiper performs inching wiping operation.

Front wiper OFF

When the wiper control handle is in "0" gear, the front wiper will be turned off.

Automatic wiping of front wiper

Pull the wiper control handle towards direction A to "AUTO" gear, and the front wiper performs automatic wiping operation. At this time, the wiper control system automatically adjusts the wiping speed according to the rainfall.

The wiping speed can be adjusted by rotating the automatic wiper sensitivity adjustment knob. When the mark "-" indicates that the scale bar narrows from wide to narrow (direction C), it means that the wiping speed changes from fast to slow.

 When scrubbing the front windshield or washing the vehicle, do not set the wiper to "AUTO" gear. At this time, the wiper may start automatically, causing injury to the vehicle or people. ◀

Front wiper wipes at low speed

When the wiper control handle is in "O" gear, pull two gears towards direction A to perform low-speed wiping operation for the front wiper.

Front wiper wipes at high speed

When the wiper control handle is in "O" gear, pull three gears towards direction A to perform high-speed wiping operation for the front wiper.

Windshield washer

Pull the wiper control handle towards direction D. At the same time, the front windshield washer sprays water, and the wiper wiping starts.

After releasing the wiper control handle, the washer stops spraying water, and the cleaning ends. The wiper continues to work for about 4 seconds (2 ~ 3 cycles).

 When the windshield is dry, try not to use wipers as much as possible; otherwise, it will scratch the glass and affect the service life of the wiper blade. If there is dust or sand on the windshield, please clear it before using the wiper; if not, it will scratch the glass and affect the service life of wiper blade. ◀

Steering wheel

Steering wheel button

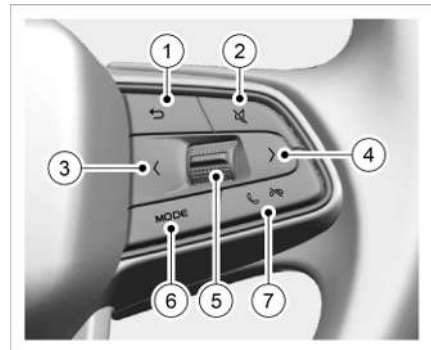

1 Return button

Press the button to return.

2 Mute button

Shortly press (in any mode) to mute/unmute.

3 Last song

Short-press: last song/preset console.

Long-press: fast backward/search forward.

4 **Next song**

Short-press: next song/preset console.

Long-press: fast forward/search backward.

5 **Middle button**

Press up:

- Short-press: Volume increases; during mute, mute is released.
- Long-press: Volume increases continuously; during mute, the mute is released and the volume increases continuously.

Press down:

- Short-press: Volume decreases.
- Long-press: Volume decreases continuously.

Press: pause/play.

6 **MODE button**

Switch the sound source.

7 **Call button**

Short-Press:

- Answer the call during a incoming call;
- Hang up the call during a call or incoming call;
- In the idle status, shortly press to enter the call interface.

Long-press:

- Reject the call during a incoming call;
- In the idle status, press and hold to dial the last call.

Horn



Press the horn icon area on the steering wheel, and the horn will sound.



Observe local traffic regulations when using the horn.

Pay attention to the surrounding environment when using the horn. For example, when there are people or animals in front of the vehicle, slow down without emergency braking or honking for a long time to avoid frightening people or animals. ◀

Steering wheel heating*



Click **Vehicle Settings - Seat System Settings - Steering Wheel Heated** on the central control screen menu to turn on function and adjust gear. There are 3 gears available.



You can also pull down the menu at the top of the screen and click the Steering Wheel Heating icon to set.

Rear mirror

Exterior rearview mirror

Adjustment of manual exterior rearview mirror

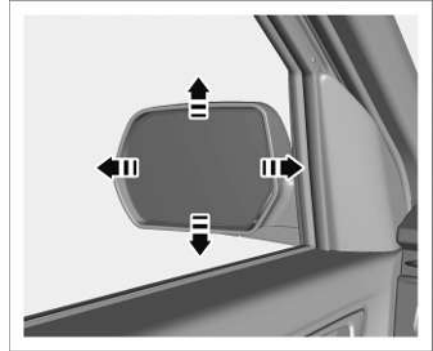

Press the edges around the lens to adjust the lens to a proper angle.

Adjustment of electric exterior rearview mirror*



1. Turn on the vehicle power supply, rotate the exterior rearview mirror adjustment switch so that the mark on the exterior rearview mirror adjustment switch points to L (left) or R (right) to select the

corresponding left and right exterior rearview mirrors.

2. Pull the exterior rearview mirror adjustment switch left, right, up and down to adjust the angle of the exterior rearview mirror lens.
3. After adjustment, reset the exterior rearview mirror adjusting switch to the initial position (O).

 When the vehicle is running, it is strictly prohibited for the driver to adjust the angle of the rearview mirror, which may cause traffic accidents. ◀

 The distance of the object seen from the exterior rearview mirror is farther than the actual distance. Please adjust your driving posture before adjusting the exterior rearview mirror.

When the exterior rearview mirror lens is frozen, please remove the ice layer on the surface of the rearview mirror to thaw the ice before adjustment.



Folding of exterior rearview mirror

The exterior rearview mirror has a folding function, which is convenient for driving through narrow laneways and parking.

Folding of manual exterior rearview mirror

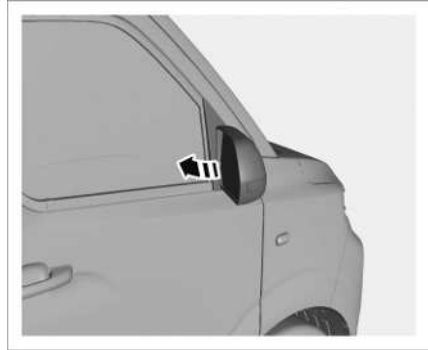

Push the exterior rearview mirror inward the vehicle body to fold the exterior rearview mirror. Push outward to open the exterior rearview mirror.

Folding of electric exterior rearview mirror*

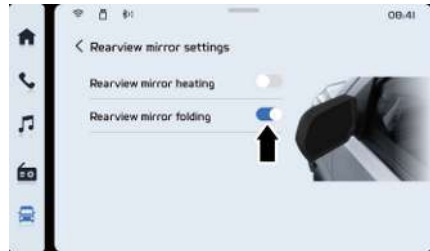

Click **Vehicle Settings - Rearview Mirror Settings** on the central control screen menu. Click the screen switch to unfold and fold the rearview mirror.

The rearview mirrors will fold automatically when the remote control key is used to lock the vehicle, and unfold automatically when the remote key is used to unlock the vehicle.

Heating of exterior rearview mirror *



In bad weather such as rain, heavy fog and cold, the rearview mirror surface becomes blurred due to mist, frost and snow. The heating function can be turned on to remove rain, snow or frost on the mirror surface. Click **Vehicle Settings - Rearview Mirror Settings** on the central control screen menu. Click the screen switch to turn on the heating function. Rearview mirror heating will automatically turn off after being turned on for a period of time.



You can also pull down the menu at the top of the screen and click the rearview mirror heating icon to turn on the function.

Window

Precautions

 It is dangerous to leave children, adults without behaviour capacity or pets in the vehicles with closed windows. They may collapse due to excessive temperature, or suffer permanent injury or even death due to heatstroke. Do not leave children, adults without behaviour capacity or pets alone in the vehicle with closed windows, especially in warm or hot weather. ◀

Electric window

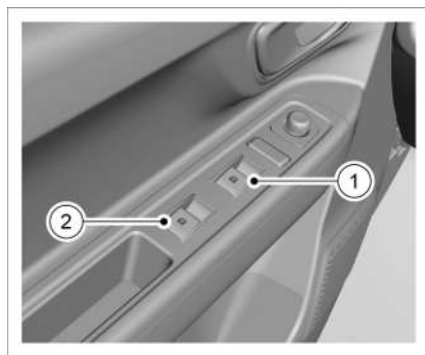

- 1 Driver side window switch
- 2 Passenger side window switch

Open/Close the window

Open: Press the window switch, and the window will automatically descend to the bottom. Pull up or press down the window switch again, and the window will stop moving.

Close: Pull up the window switch and hold it, and the window rises and then closes. Release the window switch when closing the window, and the window will stop moving.

One-button opening of window with remote control key

After locking the vehicle with the remote control key, press and hold the unlock button on the remote key, and the window will automatically lower to the open status.

 When the window is moving, please make sure that there are no obstacles.

All windows of this vehicle have no anti-pinch function. Do not put your hand out of the window when it is about to close.

Before closing the window, the driver must ensure that all passengers (especially children) do not protrude any part of their body out of the window. Otherwise, serious injury may be caused. ◀

Electric window thermal protection

If the window is operated repeatedly in a short time, the electric window control switch may fail due to the protection of motor life. To restore electric window operation, wait for a while and then the electric window can be operated again.

Interior illumination

Interior lamp

Cab reading lamp

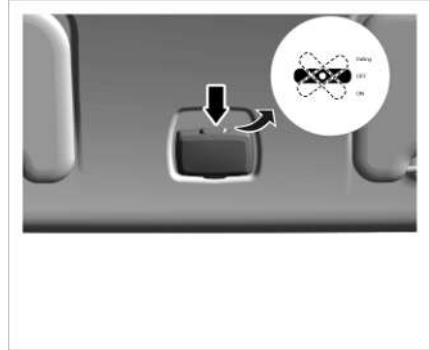

Press the reading lamp switch to the left position for door control function. The reading lamp will turn on when any front door is opened, and turn off when any door is closed.

Reset the reading lamp switch to the parallel position and turn off the reading lamp.

Press the reading lamp switch to the right position and turn on the reading lamp.

 Avoid using the interior reading lamp when driving at night. Bright interior environment will reduce the visibility in darkness and may result in collision. ◀

 If the interior reading lamp switch is on, please turn off the interior reading lamp before leaving the vehicle to avoid running out of battery. ◀

Cargo compartment reading lamp

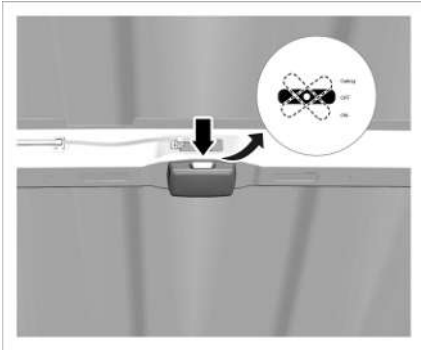

Press the reading lamp switch to the left position for door control function. The reading lamp will turn on when the side sliding door or tailgate is opened, and turn off after the door is closed.

Reset the reading lamp switch to the parallel position and turn off the reading lamp.

Press the reading lamp switch to the right position and turn on the reading lamp.

Cab description

Instrument panel switch group

Instrument panel left switch group

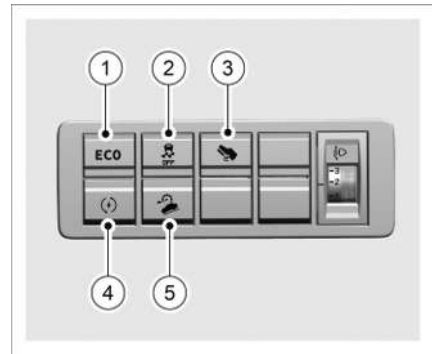

1 ECO button

Press this button to enable the economic mode, and at the same time, the instrument cluster economic mode indicator will illuminate. In the economic mode, when the vehicle is driven, its dynamic response is smooth and it can obtain a large endurance mileage.

2 Electronic stability control (ESC) OFF button

The ESC function is enabled by default. Press this button to turn off the ESC function, and the instrument cluster ESC OFF indicator will illuminate. Press this button again to enable the ESC function.

⚠ In order to maintain stable control of the vehicle during driving, it is recommended that the system be always on. ◀

3 POWER mode button

Press this button to turn on the POWER mode. At this time, the vehicle can break through the maximum speed limit of normal mode and be driven at a higher speed. In this mode, the driving range will be relatively shortened.

4 Energy recovery level button

The energy recovery level must be set when the vehicle is in D gear. Press the button continuously to switch among three levels: L1, L2, and L3. The energy recovery level is L2 by default when the vehicle is started.

The higher the energy recovery level, the more corresponding energy recovery and the shorter the vehicle sliding distance. Level 3 is recommended to be used when the vehicle is fully loaded, so as not to affect driving experience.

5 Hill descent control (HDC) button

The HDC function is mainly used to help the driver maintain a stable downhill speed through active braking, without the need for the driver to depress the brake pedal.

Press the button to turn on the instrument cluster indicator and enable the function. Press the button again to turn off the instrument cluster indicator and the disable the function.

Storage space

Glove Box



The glove box is located on the front passenger side of the instrument panel. Press the glove box opening button to open the glove box. Push the glove box inward to close it.

Door storage box

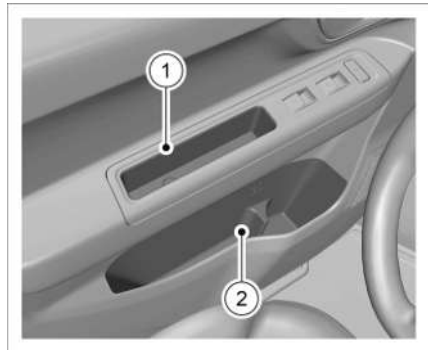

- 1 Upper door storage box
- 2 Lower door storage box

The door storage boxes are located on two doors. Some coins or small items can be placed in the upper door storage box, and articles or bottled water can be placed in the lower door storage box.

Storage box on auxiliary instrument panel

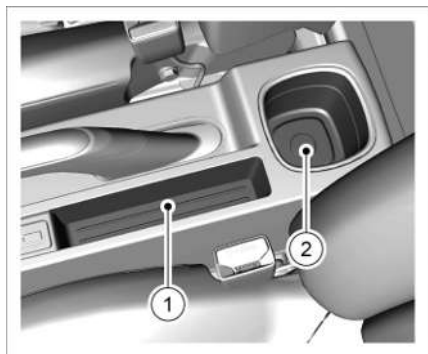

- 1 Card slot
- 2 Cup holder

The card slot can hold business cards, driving license, vehicle license or some small items.

The cup holder can hold water cups or some small items.

 Do not place hot drinks without covers on the cup holder. In case of emergency braking or sharp turning of the steering wheel, avoid scalding the driver and passengers due to overflowing hot drinks. ◀

Backup power supply

This vehicle is equipped with a 12V 120W power output port, which can be used as backup power supply to

provide power for 12V electrical equipment.



USB interface

The auxiliary instrument is equipped with two USB interfaces. Interface A supports charging operation and data transmission, while interface B only supports charging operation.

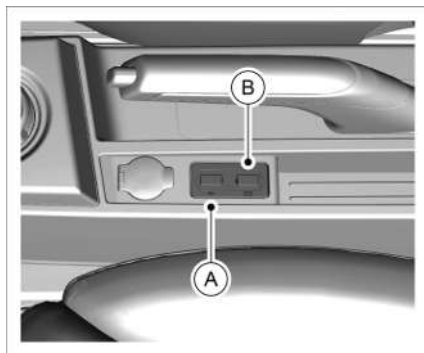

Interior handle

Safety handle on the passenger side

When the vehicle is running, passengers can maintain body balance through the safety handle.

 Do not use the safety handle when getting on or off the

vehicle or getting up from the seat. Do not hang any object or apply large pulling force on the safety handle. ◀

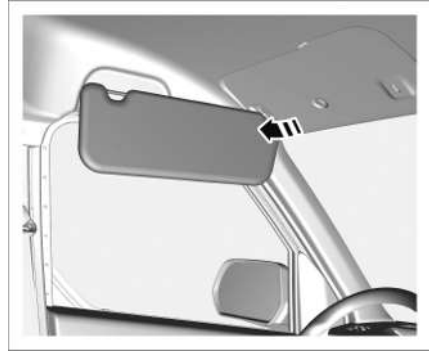
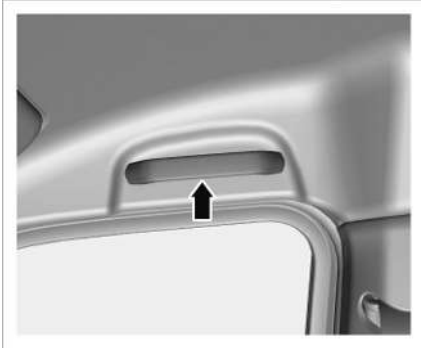

Sun visor

Sun visors are provided on the driver side and passenger side in the vehicle. Turning down the sun visor can block dazzling light from the upper part of the windshield.



Remove the sun visor from bracket on one side. Rotate the sun visor to turn it to the side, so as to block dazzling light from the side.

Air conditioning, heating and ventilation

Overview of A/C control system

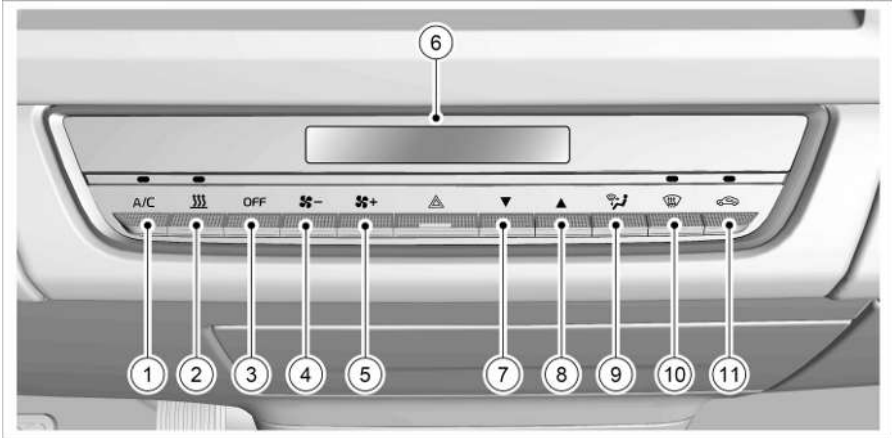

- | | |
|-----------------------------|---|
| 1 A/C switch button | 7 Temperature decrease button |
| 2 Heater button | 8 Temperature increase button |
| 3 A/C OFF button | 9 Air distribution mode button |
| 4 Air speed decrease button | 10 Defogging button |
| 5 Air speed increase button | 11 Internal/external circulation button |
| 6 A/C LCD | |

Descriptions of A/C control system button

1. **A/C switch button**

Press this button to turn on or off the A/C cooling function. If the external temperature is lower than -3°C , the cooling function will not work (but the indicator is still on).

i If the A/C performance is lower than expected, inspect the A/C condenser surface for dirt or insect accumulation. Please go to a Farizon Auto after-sales service station for cleaning. ◀

2. **Heater button**

Press this button to turn on the A/C heating mode, and the indicator will illuminate at the same time; press this button again to turn off the A/C heating mode, and the indicator will go out at the same time.

3. **A/C OFF button**

Press the button to turn off the A/C function.

4. **Air speed decrease button**

Press the button to decrease the air speed at the air outlet.

5. **Air speed increase button**

Press the button to increase the air speed at the air outlet.

6. **A/C LCD**

Display the current status of A/C.

7. **Temperature decrease button**

Press the button to decrease the air temperature.

8. **Temperature increase button**

Press the button to increase the air temperature.

9. **Air distribution mode button**

Adjust the air distribution mode, and cycle through four modes in turn: face mode, face/foot mode, foot mode and foot/defogging mode.

10. **Defogging button**

Press the button to turn on the A/C defogging mode. The AC and external circulation modes will turn on automatically at the highest speed. In this mode, the fog generated on the windshield can be removed quickly.

i If it is necessary to use heater for defogging, turn on the heater and turn off AC. ◀

11. **Internal/external circulation button**

Press the button, and the indicator will illuminate. At this time, it is in internal circulation mode. Press the button again, and the indicator will go out. At this time, it is in external circulation mode. In the external circulation mode, the interior air and exterior air can be circulated to improve the interior air. The internal circulation mode circulates the internal air in the vehicle, which

is helpful to quickly cool or heat the interior air and prevent external air and peculiar smell from entering the vehicle

i When the outdoor temperature is high, it is recommended to use internal circulation in order to reduce energy consumption and quickly lower the cab temperature. In winter, it is recommended to use external circulation to prevent the fog in the cab, so affecting driving safety. ◀

⚠ Do not use the internal circulation mode for a long time, which may lead to stale air in the vehicle and fog on the windows. It may also accelerate driver fatigue and distract the driver's attention, thus causing traffic accidents and personal injury. ◀

A/C ventilation system

Location of air outlets

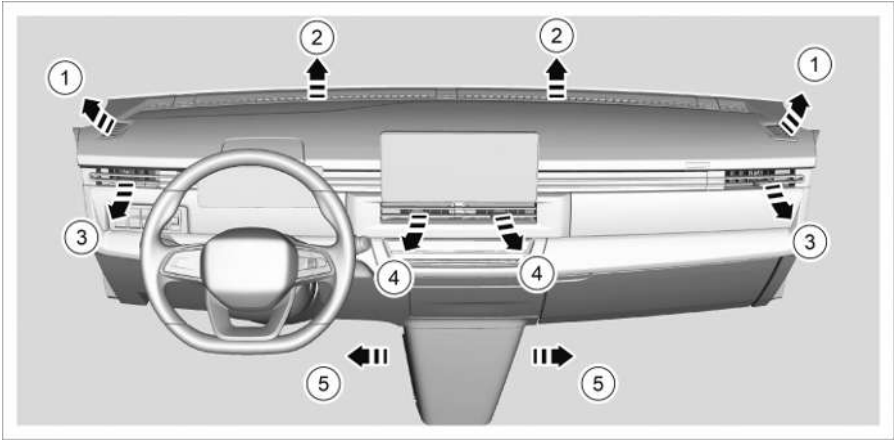

1 Side defogging air outlet

4 Middle air outlet

2 Middle defogging air outlet

5 Foot air outlet

3 Side outlet

Air outlet adjustment and A/C maintenance

Adjust air outlet

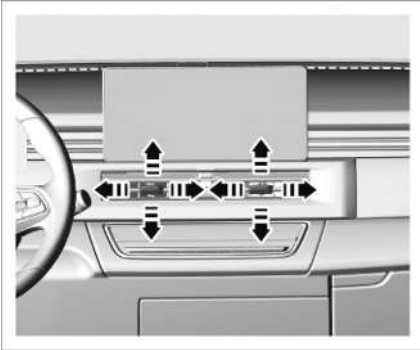

Toggle the middle adjustment switch of air outlet up and down, left and right to adjust the blowing direction of air.

Close the air outlet



Push the adjustment switch inward to the end of the middle two air outlets, and close the air outlet.



Push the adjustment switch outward to the end of the outside air outlet and close the air outlet.

Maintenance of A/C system

- If the vehicle is parked for a long time in the hot sun, the temperature inside the vehicle will rise very high. In this case, all windows should be opened first to let hot air outside the vehicle before turning on the AC button. When the temperature inside the vehicle gets lower, close the window, and then adjust the temperature inside the vehicle as needed.
- If it is humid, do not direct the cold air to the windshield for fear of fogging up the windshield due to the temperature difference between the outside and inside of the windshield.
- When driving on a dusty road, close all windows and it is recommended that you switch to internal circulation mode.

- If you smoke, while the air conditioner is in operation, you may feel pricking in your eyes. This symptom is caused by the dryness of the eye film in the dry air inside the vehicle, so it becomes very sensitive to external stimuli. In this case, the external circulation should be set to exhaust the smoke.
- Regular replacement of the A/C filter element is conducive to keeping fresh air in the vehicle.

A/C filter



The A/C filter is located at the rear of the glove box. It can effectively block and filter extremely small particles such as dust, pollen and dust from getting inside the vehicle.

To get the best filtering performance, please regularly inspect the filter and replace it periodically as per the Service and Maintenance Manual. Please pay attention to the arrow direction during installation.

Long-term storage

At any time, if you want to store the vehicle or leave it unused for two weeks or more, please turn on the A/C cooling mode in READY position and run the vehicle for 3-5 minutes. This can thoroughly lubricate compressors and minimize the possibility of compressor damage when the system does not require to be activated again for a long time.

After long-term storage, it is recommended to open the door for ventilation. Turn on the air conditioner first and switch to external circulation mode for a period of time, which is conducive to keeping the interior air fresh and emitting peculiar smell.

Multimedia system

Operation instructions of multimedia player

Overview



Click **Home - Settings - General - User manual** on the central control screen menu to view the IVI user manual.

Seat

Driver's seat

 Do not adjust the seats when the vehicle is running; otherwise the vehicle may get out of control, which may result in car crash, serious damage or injury.

Always adjust the seats when the vehicle is stationary and before the seat belts are fastened. It may cause serious injury if the seat belt is not properly fastened. ◀



1 Seat forward/backward adjustment lever

2 Seat backrest adjusting lever

Seat forward/backward adjustment



Pull the seat forward/backward adjustment lever, slide the seat to the desired position and then release the lever.

 After adjustment, slightly rock the seat back and forth with your hand to confirm that it has been adjusted in place and locked. ◀

Backrest angle adjustment



When it is necessary to adjust the backrest angle, pull the seat backrest adjustment handle to unlock the backrest. After the backrest is moved

to the required position, release the handle to lock the backrest.

- i** After adjustment, slightly rock the backrest forward and backward to confirm whether it is adjusted in place and locked.

When the backrest is laid flat, please hold it with one hand to slowly adjust it so as to prevent damage to people and objects caused by quick tilting of the backrest forward. ◀

- ⚠** The seat belt can provide maximum protection in case of vehicle collision only when the driver sits upright and his/her backrest is not skewed left or right. If the driver leans against the seat, the waist belt may slip over the hips and directly exert pressure on the abdomen, or the neck may touch the shoulder belt. Or, if the backrest inclines too much, the risk of personal injury and casualty will be increased in case of a front collision. ◀

Lift the seat

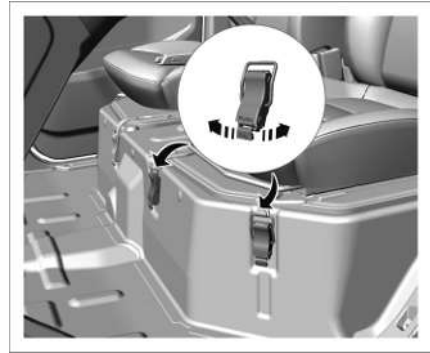

Lower the seat backrest, pull the seat fixing lock catch to disengage it from the seat fixing hook and then lift the seat.

After lowering the seat, hang the seat fixing buckle on the seat fixing hook and press down the seat fixing buckle hard to lock it.

- ⚠** After lifting the seat, keep it in a fixed position to prevent it from falling suddenly and hurting your body. ◀

Passenger seat

Passenger seat adjustment

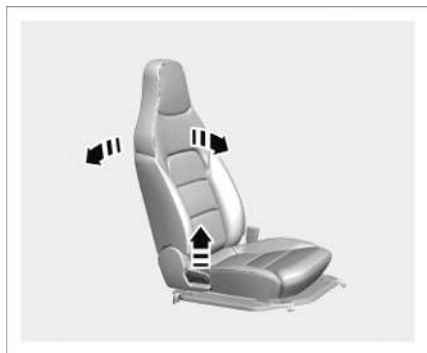

The passenger seat only supports backrest adjustment. When it is necessary to adjust the backrest angle, pull the seat backrest adjustment handle to unlock the backrest. After the backrest is moved to the required position, release the handle to lock the backrest.

Refer to the description of driver's seat section for the way to open the passenger seat.

i After adjustment, slightly rock the seat backrest forward and backward to confirm whether it is adjusted in place and locked.

When the backrest is laid flat, please hold it with one hand to slowly adjust it so as to prevent damage to people and objects caused by quick tilting of the backrest forward. ◀

Seat ventilation and heating

Seat ventilation / heating*

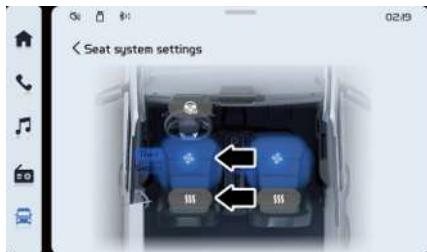

Tap **Vehicle setting - Seat system settings** on the central control screen menu to select the driver's seat or front passenger's seat, and turn on and adjust the seat heating or ventilation function. Tap the heating or ventilation icon to switch gears circularly.



You can also pull down the menu at the top of the screen and click the corresponding button to turn on the ventilation or heating function.

⚠ To avoid burns caused by prolonged use of the seat heating function, temperature control systems and seat heaters should be used with care for persons suffering from peripheral nerve disease or limited pain perception due to

age, diabetes, neurological injury or other conditions. ◀

⚠ The seat heating function can only be turned on when the vehicle is started, which can greatly reduce the battery power consumption.

If the battery voltage is too low, the seat heating function will be automatically turned off so that the vehicle has sufficient power.

◀

Seat adjustment parameters

In the initial position, the adjustment parameters of the seat are as follows:

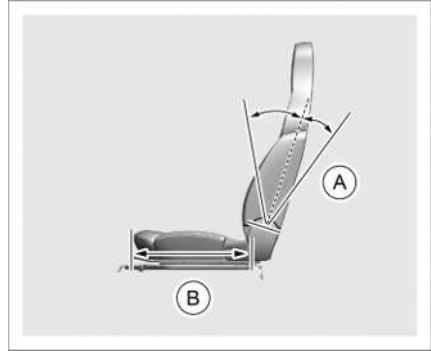

A Backrest angle

B Cushion depth

	Item	Value
Driver's seat	Forward and backward adjustment	Total travel: 90 mm Forward: 70 mm Backward: 20 mm
	Backrest adjustment	Total stroke: 98° Forward: 54° Backward: 44°
	Cushion depth	479mm
Passenger seat	Backrest adjustment	Total stroke: 98° Forward: 54° Backward: 44°
	Cushion depth	479mm

Seat belt

Overview of seat belt

This section will explain the ways to use the seat belt correctly and also some prohibited operations in using the seat belt.

 This vehicle is a commercial vehicle. The seats and seat belts are specially designed for adults, and there is no child seat interface. Therefore, children or infants are prohibited from driving or riding. ◀

 No one is allowed to sit in a seat where the seat belt fails to be used. In the event of a collision, if you or the passengers in the vehicle do not wear a seat belt, the degree of injury may be much more serious. You may hit objects in the vehicle hard or be ejected out of the vehicle. You and passengers may be seriously injured or even die. If you fasten your seat belt, the degree of injury will be reduced in the same collision. Therefore, be sure to fasten your seat belt, and check whether the passengers of the vehicle also properly fasten their seat belts. ◀

 No one is allowed to sit in the area of the vehicle without seats and seat belts. Make sure that everyone in the vehicle is seated

and their seat belts are properly fastened.

This vehicle is equipped with a seat belt warning lamp to remind you to fasten your seat belt. You must fasten your seat belt during driving. The reason is as follows: You can't predict whether there will be a collision. Even in a collision, you can't predict the severity of the accident. In many such collisions, people wearing seat belts can reduce injuries, and some are able to walk away from the accident site. If they don't fasten seat belts, they may have been seriously injured or died. The experience of using seat belts in vehicles for more than 40 years has clearly shown that in most collisions, whether the seat belt is fastened or not has a great relationship with casualties in the accidents! ◀

Why can the seat belt provide protection

When you are sitting in or on a certain object, you move with the same speed as the object. Take the simplest vehicle as an example: suppose that the vehicle is a seat with wheels on it. Let people sit on it, accelerate and then stop it. People in the vehicle will not stop because of inertia. On the contrary, the person keeps moving forward until he/she is stopped by an object. In an actual vehicle, the object may be the

windshield, the instrument panel or the seat belt.



After you fasten your seat belt, you will slow down with the vehicle. You have more time and longer distance to stop moving, and the strongest bones in your body will bear the force. This is the reason why the seat belt plays a very important role.

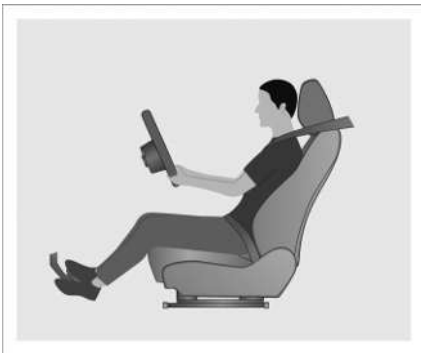

Correct sitting posture

Importance of correct sitting posture

Correct sitting posture is essential for the seat belt to play its best protective role. The driver's and front passenger's seats can be adjusted in multiple directions according to the

physical conditions of the passengers. Proper sitting posture can ensure:

- Accurate, effective and safe operation of the vehicle.
- Effective support for the body to avoid driving fatigue.
- Maximum protective effect provided by the seat belt.

 Never tilt the backrest too much during driving to avoid serious injury. ◀

Correct sitting posture also requires no problem with seats and seat belts:

- Push the seat backrest forward and backward by hand to confirm that it is firmly locked. Otherwise, it will hinder the normal operation of the seat belt.

- Make sure that the seat belt is not twisted or clamped under the seat, but placed in a proper position for use.

 During driving, don't put your head or arm out of the window; otherwise fatal injury will occur. ◀



 When driving, do not lean forward. Make sure there is a sufficient distance between your body and the steering wheel. ◀

Correct driver sitting posture

The correct driver sitting posture of the driver is essential for safe driving. It can reduce the risk of injury for your own safety. It is recommended that the driver make the following adjustments:



- Adjust the steering wheel: the distance from the steering wheel to the chest should not be less than 30 cm.
- Adjust the driver's seat back and forth: it is convenient for the driver

to operate the accelerator pedal and brake pedal effectively.

- The head shall be attached to the position of the head restraint.
- The backrest should be in an upright position, and the back should be completely attached to the backrest.
- Wear the seat belt properly.

Correct passengers seating posture

For your own safety and to avoid the risk of injury, it is recommended that passengers make the following adjustments:

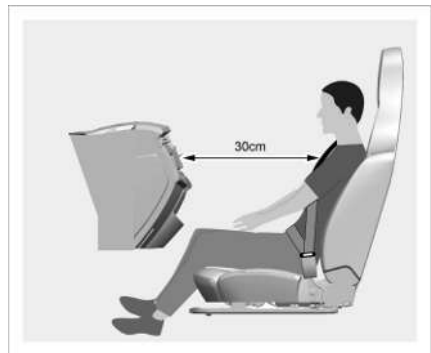

- The distance between the passengers and the instrument panel shall not be less than 30 cm.
- The backrest should be in an upright position, and the back should be completely attached to the backrest.
- The head shall be attached to the position of the head restraint.
- Wear the seat belt properly.

How to wear seat belt correctly



First of all, there are some important information that you should know before you or the passengers fasten the seat belt. The protection regulations and special requirements relevant to seat belts for children and infants are different.

i The instructions described in this section applies only to adults. ◀

⚠ This vehicle is a commercial vehicle. The seats and seat belts are specially designed for adults, and there is no child seat interface. Therefore, it is forbidden to carry children. ◀

Statistics show that people who don't fasten seat belts are more likely to get hurt than those who have fastened seat belts in the event of a collision. Passengers who do not fasten seat belts may be thrown out of the vehicle in the event of a collision. And they will hit other people in the vehicle who have fastened seat belts.

Sit up straight and always put your feet on the front floor. The hip belt should be as low as possible and close to the buttock, and it shall contact the thigh. In the event of a collision, the hip belt can exert force on the stronger hip bone, and it will also reduce the possibility of you slipping under the hip belt. If you slide under the hip belt, it belt will exert force on your abdomen. This may cause serious or even fatal injuries. The shoulder belt should be over the shoulders and across the chest. These parts of the body can bear the restraining force of the seat belt best. In case of emergency braking or a collision, the shoulder belt will be locked.

Use of seat belt

The seat belts used on both sides of the vehicle are three-point seat belts. The following instructions will clarify how to wear the seat belt correctly.

1. Pick up the latch and pull the seat belt across your body. Don't twist the seat belt.

i If the seat belt is pulled over the body too fast, it may be locked. If this happens, unlock the seat belt by retracting it a little. Then slowly pull the seat belt across the body. ◀

2. Press the latch into the buckle until you hear a click sound. Pull the latch to make sure it is locked. Locate the release button on the

buckle so that the seat belt can be unfastened quickly if necessary.

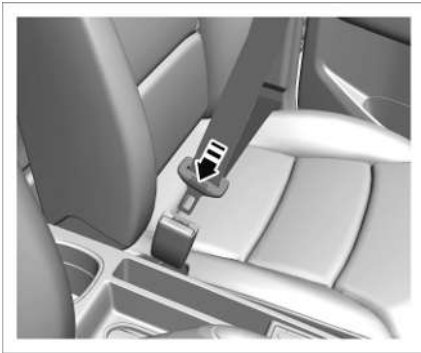

3. Pull up the shoulder belt to tighten the hip belt.
4. If you want to unfasten your seat belt, just press the red button on the buckle. Seat belts should be rolled back to the unused status.

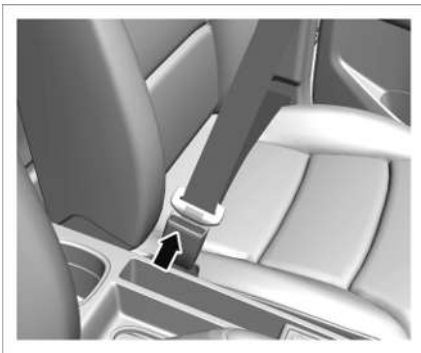

- ⚠** To prevent the seat belt from bumping the periphery due to too fast rolling or getting stuck due to too slow rolling, please put the seat belt back to its original position after unfastening it. ◀

- ⚠** Before closing the door, make sure that the seat belt will not be caught by the door. If the door is closed hard when the seat belt is clamped, both the seat belt and the vehicle will be damaged. ◀

Use of seat belts for pregnant women



Pregnant women shall also wear the lap belt across their hips as low as possible like other passengers. The shoulder belt shall be stretched obliquely along the shoulder and across the chest. Avoid the seat belt touching the raised abdomen. The lap belt must be placed flat on the thigh and as low as possible. If the seat belt is not fastened correctly, pregnant women and fetuses may be seriously injured or even die in case of emergency braking or collision.

Seat belt unfastened warning

The vehicle is equipped with the driver and passenger seat belt reminder function to remind the

driver and passengers to fasten their seat belts. If the driver's seat belt is not fastened in time, this indicator will keep on and give a prompt tone after reaching a certain speed. When the seat belt is fastened, this indicator will go out automatically and the prompt tone will stop. Please refer to "Introduction to Warning Lamps and Indicators" [▶ 31] in "Instrument and control" for the specific location of the warning lamp.

 Fastening your seat belt correctly can reduce the risk of injury in emergency braking and traffic accidents. Therefore, please always wear the seat belts correctly during driving. If the illuminated warning lamps, corresponding tips and warning instructions are ignored, serious personal injury or traffic accidents may be caused. ◀

Maintenance of seat belt

Inspection of seat belt

Please check the seat belt system regularly for the following items:

- Check whether the seat belt warning indicator, seat belt, buckle, latch, retractor and fixing device all work normally.
- Check the seat belt system for any other loose or damaged parts that may affect the normal operation of the seat belt system.

- If the seat belt is cracked or worn, replace it with a new one immediately.
- Make sure the seat belt warning lamps work normally.
- Keep the seat belt clean and dry.

Maintenance of seat belt

Please keep the seat belt clean and dry. When cleaning the seat belt fabric, use neutral soapy water or recommended interior trim cleaning solution. Then wipe it dry with a dry cloth and dry it in the shade. Do not roll the seat belt back into the retractor before it is completely dried.

 It is absolutely not allowed to remove the seat belt for cleaning.

Do not attempt to repair the damaged seat belt by yourself, and do not disassemble or modify the seat belt under any circumstances.

Do not bleach or dye the seat belt. Otherwise, it may significantly degrade the strength of seat belt. In case of a collision, the bleached or dyed seat belt may not be able to provide sufficient protection. ◀

Airbags

Overview of airbag

The front airbag can effectively protect the passengers from head

and chest injuries caused by frontal collision.

In case of medium to heavy frontal or nearly frontal collisions, if the system triggering conditions are met, the airbags will be inflated to buffer the forward collision of the driver and the front passenger, so as to prevent them from directly hitting the steering wheel and the instrument panel.

Location of airbag

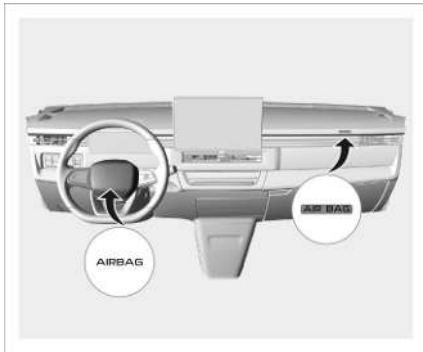

The vehicle is equipped with 2 front airbags marked with the word "AIRBAG". They are respectively installed in the center of the steering wheel and in the instrument panel on the upper part of the glove box.

- ⚠ The front airbag is not designed for rear collision, slight frontal collision or vehicle overturn. It does not work during emergency braking, either.

The expansion and contraction of the airbag is completed in a very short time, which cannot protect the influence of the

second collision that may occur later.

To give full play to the protective function of the front airbags, all drivers and passengers must fasten seat belts correctly and keep a correct sitting posture during driving. ◀

- ⚠ It is forbidden to place objects in the front airbag deployment area of the instrument panel or steering wheel, as they will hinder airbag deployment or cause serious injury or death to passengers due to large injection force when the airbag deploys. Similarly, do not place objects in the arms or on the knees of the driver and front passenger.

Do not refit, remove, knock or open any front airbag component or the circuit, such as steering wheel, passenger airbag cover and airbag electronic control unit. Any of the above actions may suddenly inflate the airbags or disable the system, resulting in serious injury or death. ◀

- ⚠ Do not sit on the edge of the seat or lean against the instrument panel while the vehicle is in use, as the front passenger airbags will inflate with considerable speed and force. Any person leaning against or close to the airbag

when the airbag is inflating may suffer severe injuries or even death. Make sure you keep at least 30 cm away from the airbag.

It is forbidden for the front passenger to hold a child at the front passenger's position, because the child may be squeezed between the passenger and the instrument panel during emergency braking or collision, causing serious injury. If the collision is severe, the airbag may deploy and that may cause serious injuries or even death to the child.

Since the airbag has a considerable speed and strength when deployed, it is forbidden for young children to stand up or kneel on the front passenger's seat; otherwise it will cause death or serious injury to young children. ◀

 In case of the following conditions, contact a Farizon Auto after-sales service station immediately for maintenance.

- Airbag is deployed.
- The front part of the vehicle was collided, but the airbag is not deployed.
- The airbag warning lamp illuminates.

- The airbag cover surface has cracks, scratches or other forms of damage. ◀

Airbag deployment

Airbag deployment

The front airbags are deployed when the vehicle collides with a solid wall at a speed of 25 km/h or more.

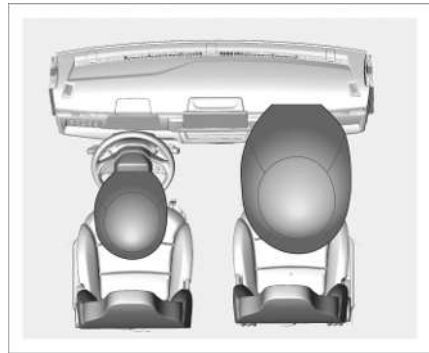

 To reduce the injury caused when an airbag is deployed, you must always keep your seat belt fastened. In addition, the driver and the front passenger must adjust the seat position to keep a sufficient distance from the front airbags. ◀

In case of collision, the airbag control unit monitors the deceleration caused by collision and determines whether the airbag should be deployed. Whether the airbag works does not depend on the vehicle speed, but depends on the object and direction of collision, as well as the rate of deceleration caused by collision. Whether the airbag is deployed or not should not be judged

according to the severity of vehicle damage. In case of severe frontal collision, two front airbags will be deployed.

Airbags may deploy if

- The vehicle is collided by other stationary vehicles;
- The vehicle collides with easily deformable objects, such as trees;



- The vehicle collides low and short objects like steps strongly when it is running;

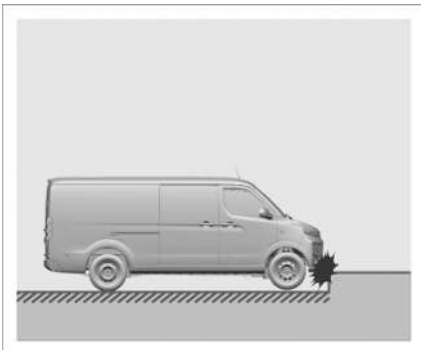

- The vehicle falls in a deep pit or trench;



- This vehicle collides with other vehicles in a frontal offset manner;

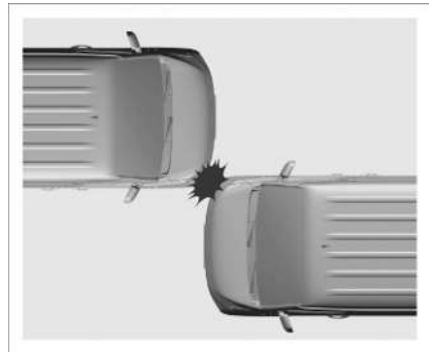

- Tip-over;
- Side collision, rear collision and slight frontal collision;
- The airbag system is faulty;
- Other special circumstances.

 Under various special circumstances, even if the front airbag does not deploy, there are other protective devices that can protect you and ensure your safety. ◀

If the airbag deploys

When the airbag deploys, it will make a loud sound and eject a small amount of white gas.

Airbag module components (airbag cover, gas generator and air bag) may be very hot within a few minutes of deployment.

Collision with the deployed airbag may cause slight burns, skin congestion and minor abrasions.

 The airbag inflates and expands very quickly. In some cases, contact with the inflating airbag will cause mild abrasions, bumps and other injuries. Please seek medical attention immediately.

The airbag inflation gas contains a trace of irritant substances, and its dosage is harmless to the health of ordinary people, but it has an impact on respiratory patients or allergic patients. Therefore, when the airbag is deployed, it is necessary to open the window immediately for ventilation or leave the vehicle under safe conditions.

If your skin, eyes, nose and throat are uncomfortable, please wash them with clean water and breathe fresh air. If it still cannot be relieved, please seek medical treatment immediately. ◀

Airbag malfunction indicator

 Do not maintain, repair, disassemble or replace any parts of the airbag system without authorization; otherwise the system may not work. ◀

SRS fault indicator - red

 When the airbag warning indicator is in normal status, it will illuminate for self-inspection when the start switch is turned to "ON" position. It will go out after the self-inspection is normal. If the airbag malfunction indicator is always on or flashes intermittently, it indicates that there is a system fault. In this case, contact a Farizon Auto after-sales service station.

When the airbag system fails, its components may not work and cannot be effectively protected in case of an accident. Please contact a Farizon Auto after-sales service station for maintenance as soon as possible.

Airbag warning label



Please pay attention to the airbag warning label pasted on the sun visor at passenger side. Do not put backward facing child seat on the seat protected by an airbag, otherwise death or serious injuries may be caused.

Key

Remote control key

The provided remote control key has been programmed according to safety system of the vehicle. You cannot use a remote control key not programmed in this way to start the vehicle. If the remote control key is lost or damaged, you can get a new one only from a Farizon Auto after-sales service station. Please take good care of the bar code bound to the remote control key, which is required when replacing or matching the key.

If your remote control key is lost or stolen, please contact a Farizon Auto after-sales service station as soon as possible to cancel the vehicle starting function of the lost key. If the remote control key is found, the Farizon Auto after-sales service station can reactivate its function.

The remote control key only works within a specified range. Please note that its working range may be affected due to physical or geographical factors. For safety, please verify the operation validity when you use the remote control key to lock.

Only when the start switch is turned off (in OFF position) and all doors are closed, can the vehicle be locked with the remote control key. If any door is not closed, the vehicle cannot be locked.

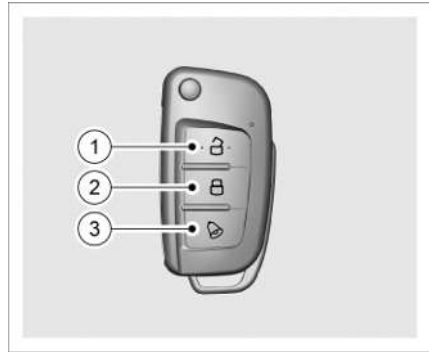

- 1 Unlock button
- 2 Lock button
- 3 Locate button

i If the remote control key or central control lock fails, you may use the mechanical key to unlock or lock the driver's door. Similar frequencies may interfere with the remote control key signal. In this case, please keep the remote control key at least 30 cm away from other electronic products. ◀

Press the release button on the front of the remote control key, and the key rack will pop up automatically.



Remote control key battery replacement

If you find that the remote control key control distance is close, or the remote control function fails, or the vehicle cannot identify the remote key as the key battery capacity is low, it is necessary to replace the key battery.

1. Pry up the housing with a suitable tool, and protect it with a piece of cotton cloth during removal.





2. Remove the remote control key battery mounting plate and replace it with a new one. Pay

attention to the positive orientation of the battery as indicated on the circuit board. Remote control key battery model: 3V, CR2032.



3. Snap the battery mounting plate and remote control key housing in place.

 A precision circuit is integrated within the remote control key. Please take care to protect the key from collision, water, high temperature, humidity, direct sunlight, solvent, wax and detergent corrosion. ◀

 Do not expose the remote control key directly to the environment below -20°C for a long time; otherwise, an alarm of low power may appear because the chemical non-reaction of battery characteristics. When there is a low battery alarm of the remote control key, please replace the battery in time. This is to prevent the remote control

function from being affected, causing failure of starting the vehicle and affecting the use of the vehicle. ◀

Anti-theft System

Anti-theft System

This vehicle is equipped with an anti-theft system. When the vehicle is locked with the remote key, it will enter the anti-theft status. When the system detects that any door is opened or the vehicle is powered on without using the remote key to unlock the vehicle, it will trigger an anti-theft alarm. The horn starts to sound at a certain frequency and flashes with the hazard warning lamp. Release the anti-theft function after unlocking the vehicle with the remote control key.

 Do not leave the remote control or mechanical key in the vehicle, otherwise there is a risk of vehicle being stolen. ◀

Vehicle locking and unlocking

Unlocking and Locking

Remote unlocking and locking



Unlocking

Press the unlock button on the remote control key, and all doors will be unlocked. The turn signal will flash once, and the vehicle will exit the anti-theft status.

Locking

Press the lock button on the remote control key, and all doors will be locked. The turn signal will stay on for 1 second and go out, and the vehicle will enter the anti-theft status. When any one of the four doors is not closed and the remote control key performs locking operation, the vehicle will perform locking action. The horn sounds twice and the turn signal flashes 4 times to remind door closing.

Vehicle locating

Press the vehicle locating button on the remote control key, and the position lights will be on. The left and right turn signals will flash 3 times, and the horn will sound 3 times.

Unlocking and locking doors with mechanical key

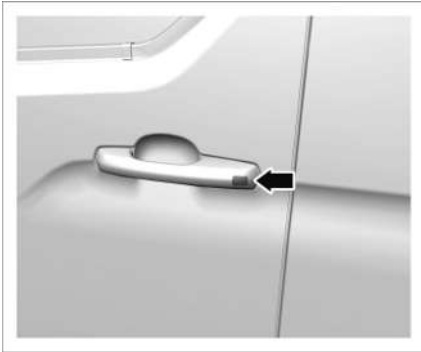

Pry out the driver door lock cylinder trim cover with a suitable tool to expose the driver door lock cylinder.

- ⚠️ Wrap the tool with a soft cloth during operation; otherwise, the surface of door handle will be scratched. Be careful not to break the clip behind the trim cover. ◀

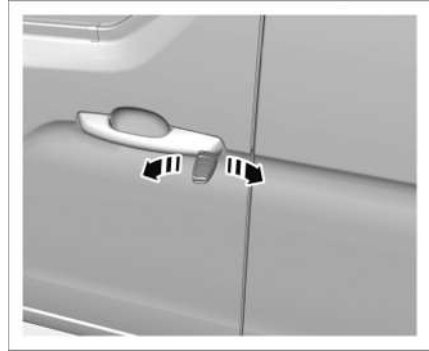

Unlocking

Insert the key into the driver side door lock and rotate it clockwise to unlock the door.

Locking

Insert the key into the driver side door lock and rotate it counterclockwise to lock the door.

- i If the vehicle is in the remote locking anti-theft status, by inserting the key rack into the lock cylinder to unlock the door, the vehicle anti-theft alarm function will be triggered when the door is opened. The mechanical key cannot release the anti-theft function, so it is necessary to unlock the vehicle with the remote control key to release the anti-theft alarm.

It is recommended to use this method only under special circumstances, such as when the remote key battery is too low.

It is recommended to carry the remote control key with you. ◀

Interior unlocking and locking





Unlocking

Press the unlock button  on the driver door combination switch to unlock the door.

 Interior unlocking can only be carried out when all doors are locked. ◀

Locking

Press the lock button  on the driver door combination switch to lock the door.

 Interior locking can only be carried out when all doors are closed. ◀

Emergency locking function

This scenario is applicable to the case where the vehicle cannot be locked with the remote control key but the door needs to be locked when the power of the vehicle is insufficient or the battery of the remote control key is dead.

1. Locking the tailgate: Insert a key into the tailgate lock hole, turn it clockwise to lock the tailgate and pull out the key.



2. Locking the side sliding door: Push the interior locking switch of the right sliding door to lock the left side, and then close the right sliding door to lock it.



3. Locking the front passenger door: Insert the key into the emergency lock hole of the front passenger door lock, lock the emergency locking switch downward, and then close the door to lock the front passenger door.



4. Lock the driver's door with a mechanical key to complete all locking processes.

Automatic Locking

When the vehicle is unlocked and all doors, front cover and tailgate are closed, the vehicle can be locked automatically when the driving speed exceeds 20 km/h.

Automatic re-lock

After the vehicle is unlocked with the remote control key, if no door opening or other operations have been performed on the vehicle, the vehicle will automatically re-lock after 30 seconds.

Collision unlocking

After a collision accident, the door lock will be unlocked while the airbag pops up. At this time, the hazard warning lamp flashes and the high voltage system is powered off so that drivers and passengers can quickly and safely leave the damaged vehicle.

Vehicle is started

Start switch

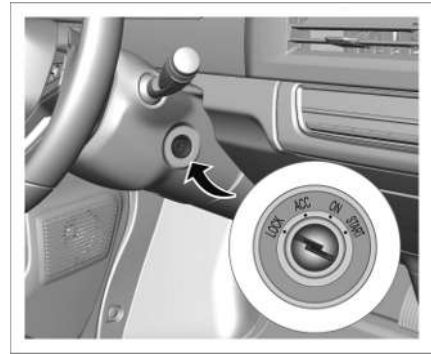

Insert the key into the ignition lock cylinder and rotate the key to different positions.

The start switch status can be divided into:

LOCK/OFF: The vehicle is powered off. When the key is in LOCK/OFF position, depress the brake pedal and turn the key to START to directly start the vehicle.

ACC: low-voltage battery power supply status. When the vehicle is not started, turn the key to ACC mode without depressing the brake pedal. When the Start switch is turned to ACC position, depress the brake pedal and turn the key to the Start switch once to start the vehicle, and the vehicle enter a drivable status (READY status).

 When the vehicle is not started and the Start switch is at ACC position, the battery power will be consumed. If the low-voltage

battery is consumed for a long time, you may not be able to start the vehicle.

When the A/C or entertainment function is used for parking, it is recommended to set the vehicle power mode to ON or READY. ◀

ON: power supply status of the traction battery. Without depressing the brake pedal, turning the key to ON position will turn the vehicle power supply to ON mode. When the Start switch is turned to ON position, depress the brake pedal and turn the key to START. The vehicle can be started and enters a drivable status (READY status).

START: drivable status (READY). Depress the brake pedal and turn the key to START position, so that the vehicle will enter READY status.

i The steering wheel has a locking function, and can be locked after the key is removed. If it is found that the key is not easy to rotate after inserting the key, turn the lower steering wheel left and right slightly. ◀

Vehicle starting procedure

Starting procedure

Turn the key to different power positions as required. To drive the vehicle, depress the brake pedal and turn the key to START. The vehicle is ready for driving (READY).

i When it is confirmed that the READY indicator on the

instrument cluster and the vehicle can run normally, observe the SOC display of the instrument cluster at this time to understand the battery capacity of the vehicle before arranging the vehicle traveling plan. When the SOC of the vehicle is lower than 30%, it is recommended to recharge before driving, so as not to add unnecessary trouble to the trip.



Vehicle start failure

Before inspection, the vehicle must be started according to the correct starting procedure of "starting the vehicle" [▶ 75], and confirm whether the power battery and low-voltage battery have enough power.

Before starting the vehicle, observe whether any fault warning lamp on the instrument cluster illuminates. If yes, it may be caused by system failure of the vehicle. Please contact a Farizon Auto after-sales service station for maintenance.

This vehicle is equipped with an electronic anti-theft system. Check whether the vehicle can be started by using other spare keys. If the vehicle can be started, your intelligent key may be out of order. Hand over your key to a Farizon Auto after-sales service station for maintenance. If all your keys fail, the system may be faulty. Please contact a Farizon Auto

after-sales service station for maintenance as soon as possible.

If you find that sometimes the vehicle fails to start:

1. Check whether the intelligent key has insufficient power.
2. Check whether the vehicle is equipped with radio interference equipment.
3. Check whether the battery terminal is tightened and clean.
4. If there is no problem with the wiring terminal of low-voltage battery, it may be that the low-voltage battery has run out. You can try to start by jumping. Please refer to "Jump Start" [▶ 97] in Chapter 7 "Faults during Driving". If it still cannot be started (READY status), please contact a Farizon Auto after-sales service station for maintenance.

Driving precautions

Vehicle driving operation

1. Start the vehicle, depress and hold the brake pedal, turn the gear knob to D position, and "D" will be displayed on the instrument cluster.
 Before gear shifting, the vehicle needs to be in READY status and confirm that the "READY" indicator on the instrument cluster is on. When the gearshift operation is wrong, the instrument cluster gear display

icon will flash 3 times with 1 prompt tone. ◀

2. Release the hand brake.
3. Release the brake pedal and the vehicle starts to creep; gently press the accelerator pedal, and the vehicle starts to run
4. For acceleration, step on the accelerator pedal gradually; for driving at a constant speed, keep the accelerator pedal at a certain opening
5. For braking, depress the brake pedal.
6. For reversing, depress the brake pedal until the vehicle stops steadily and keep it still. Turn the gear knob to R position, and "R" will be displayed on the instrument cluster. Release the brake pedal and gently depress the accelerator pedal to start reversing.

 Do not step on the accelerator pedal during shifting to avoid losing control of the vehicle. ◀

 Do not depress the brake pedal and accelerator pedal simultaneously when driving. ◀

 Emergency braking should be avoided while the vehicle is running. The vehicle shall slow down as much as possible during turning, and turning sharply is prohibited. Before turning, attention shall be paid to whether there are other

vehicles or pedestrians on the left rear and right rear sides. Slow down to avoid other vehicles or pedestrians, and emergency acceleration is prohibited during turning. ◀

 When the vehicle is in READY status and the gearshift lever is at D position, be sure to depress the brake pedal or pull up the handbrake; otherwise, the vehicle will creep. If you leave the vehicle, be sure to apply the parking brake and shift to N position. ◀

Running-in of new vehicle

Running-in of new vehicles is performed mainly to improve the surface quality and friction and wear status of moving parts, extend the service life and save power consumption. After purchasing a new vehicle, please carry out running-in according to the following requirements. The running-in period is measured in 5,000 km. Please follow the simple instructions below during initial use:

- Before running-in of a new vehicle, carefully check the oil, water and fluid capacities on a daily basis. In case of insufficiency, fill according to regulations. The tire pressure shall meet the requirements of vehicle parameters.
- When starting and driving, do not depress the accelerator pedal to the floor or accelerate rapidly.

- During the running-in period, vehicles should be driven on flat roads and muddy or sandy roads must be avoided.
- Avoid emergency braking within the first 300 km.
- Do not drive at high speed for a long time.
- The vehicle shall be fully charged rather than fully discharged

Eco drive

Driving range and power battery capacity of the vehicle will be affected by driving habits, storage conditions, charging modes, power battery temperature, etc. Good use and driving methods can improve the driving range of vehicles.

1. Smooth start and acceleration:
The power consumption during the start and acceleration is high. Try to avoid slamming on the accelerator pedal to start and accelerate when driving the vehicle. Smooth start and acceleration can save the electric quantity.
2. Keep a proper distance from the vehicle in front and try to avoid frequent braking; slow down at a red light, let the vehicle slide, and avoid sudden braking.
3. Keep the wind resistance of the vehicle low: The wind resistance of the vehicle will obviously increase if the windows are

opened at a high speed, increasing power consumption.

4. Maintain a suitable tire pressure: Check the tire pressure periodically. The rolling resistance of tires will increase if the tire pressure is too low, increasing the power consumption.
5. Switch on the A/C as little as possible: the power consumption of the power battery will increase in both cooling and heating A/C conditions. Please use the A/C when necessary. Open windows for ventilation at the low speed. Select the internal circulation mode of the A/C to save more energy.
6. Reduce the vehicle load: every additional kilogram of weight may increase the power consumption, and remove unnecessary luggage on the vehicle regularly.
7. Plan the driving route: optimize the route and try to avoid congested sections. This saves time and helps to reduce power consumption.
8. Do not change the size of tires at will: using larger or wider tires will result in higher power consumption.
9. Selection of driving mode: In case of ECO mode when the vehicle is running, lower power consumption of the vehicle and

increased driving range can be achieved.



On the premise of ensuring safety, please abide by traffic laws and regulations, and do not interfere with others or public transportation order. ◀

Precautions for use in winter

In winter or low temperature, the night temperature will decrease and extremely low temperature will affect the activity of vehicle power battery. Therefore, users with conditions should park their vehicles in underground parking lots as far as possible, or in sheltered and anti-freezing places. When the vehicle is started, ensure that the temperature of the power battery is as close to normal temperature as possible.



The driving range of the vehicle will be reduced in winter compared with that at normal temperature. Please make a travel plan in advance before driving in winter. ◀



The temperature is low in winter, and the vehicle speed may not reach the maximum running speed when the power of the vehicle is too low. In order not to affect your driving feeling, please charge the vehicle in time. ◀

Driving carefully

Driving carefully means "being always ready for unexpected situations". To drive carefully, the first thing is to

fasten your seat belt. In the following cases, special attention should be paid to the lower parts of the vehicle, such as the vehicle bottom shield and the power battery.

1. When driving on poor roads and routes.
2. When there are foreign matters on the kerb or road.
3. When driving on steep slopes and other conditions.
4. When driving through a road section requiring wading through, etc.

 Pay special attention to pedestrian safety, because the noise of electric vehicles is low, and pedestrians may not know when vehicles approach. Assume that other road users (pedestrians, cyclists and other drivers) will be careless and make mistakes, predict what they will do and be prepared. ◀

 Before driving, please confirm that the charging port cap is fully closed and the charging cable has been pulled out. ◀

 When the vehicle is fully loaded, drive with special care and do not accelerate or turn sharply. ◀

 If the bottom of the vehicle is seriously scratched during driving, please contact a Farizon Auto after-sales service station for maintenance as soon as possible. ◀

 Keep sufficient distance from the vehicle ahead. Focus on driving. Distracted drivers may cause collision, resulting in injury or death. These simple skills of careful driving may save your life. ◀

Vehicle control

The following three systems can help you control the vehicle while driving: brake system, steering system and acceleration system. Sometimes when driving on snow or ice, the adhesion provided by tires and roads is far lower than that required by the control system, which means you may lose control of the vehicle. Therefore, pay extra attention when driving on snow or ice. Do not apply emergency braking, make sharp turns and accelerate/decelerate rapidly.

 Any additional or modified non-original accessories may affect your vehicle performance. ◀

Driving through water

To avoid vehicle damage when driving through water (for example, when the road is flooded with water), please pay attention to the following items:

- Determine the water depth before driving through water, and the maximum water level shall not exceed 15 cm.
- Drive the vehicle at a constant speed of no more than 20km/h

through the wading area. If you drive through a deep water area of long distance quickly, water will enter the front engine compartment, which may damage the motor controller and other components, resulting in failure of the vehicle.

- Do not stop or reverse in the water under any circumstances.
- The waves caused by the opposite vehicle may exceed the allowable water height of this vehicle. Therefore, attention should be paid to keep the vehicle running at a constant speed when passing each other.
- Pits, muddy puddles or stones which are hidden in water may make it more difficult or even impossible for the vehicle to go through water.
- Do not drive in salt water. Salt can cause rust. Immediately flush all parts of the vehicle that have come into contact with salt water with fresh water.
- When the vehicle is driving on wet and muddy roads, the braking effect may be affected, so avoid sudden and emergency braking operation.

 When traffic conditions permit, perform intermittent braking, so as to dry the brake and clean the brake disc without affecting other traffic participants. ◀

After wading, we suggest that you contact a Farizon Auto after-sales service station for maintenance as soon as possible.

Driving on icy and snowy road

When you need to drive the vehicle on an icy and snowy road, please use appropriate tires or install antiskid chains. During driving, please always keep a safe distance from the vehicle ahead and reduce the speed appropriately according to different road conditions. Try to avoid rapid acceleration or deceleration to prevent the vehicle from losing control.

When driving on a road sprinkled with melted snow salt, a salt layer may be formed on the brake disc and shoes, which may lead to an obvious increase in braking distance. At this time, salt accumulation can be prevented by intermittently applying brakes while maintaining a greater following distance from the vehicle ahead.

Driving requirements

- Do not drive in overload condition or make the drive motor overspeed.
- Do not turn off the starting switch when the vehicle is running.
- If the power drops when the vehicle is running, please immediately contact a Farizon Auto after-sales service station for maintenance.

- Do not drive on terrain that is easy to hit the bottom of the vehicle.
- Confirm that the instrument cluster has no fault alarm signal before driving.
- During driving, if the instrument cluster shows that the power battery SOC is less than 20%, it means that the power battery is about to run out and must be charged as soon as possible.
- Please use the brake pedal to control the downhill speed during vehicle descending. It is forbidden to coast with the gear in neutral during downhill operation; otherwise, it may damage the vehicle's powertrain and increase the chance of an accident.

Parking or hold

- Park your vehicle on a suitable road.
- When parking, depress the brake pedal until the vehicle stops slowly and stably, then shift to neutral (N), and pull up the handbrake.
- If the parking position is on a slope, please place tire stoppers in front of or behind the wheels to prevent property damage caused by vehicle sliding.

 Never leave children or people with limited mobility in the vehicle. They may release the electrical parking brake and operate the electrical gear selector, which may cause the

vehicle to move, leading to accidents and serious injuries. ◀

Use requirements of the vehicles not used for a long time

For vehicles that have not been used for a long time, please maintain the power battery regularly. Otherwise, the performance of the power battery will be degraded:

- For parking in summer, please park your vehicles in a cool environment, avoid direct sunlight and keep away from heat sources.
- When the vehicle is not used for a long time, the power of the power battery SOC must be kept at 50% to 80% (50% is the best).
- Full charge must be carried out once every three months for maintenance. After full charge, please drive the vehicle or directly turn on high-power electrical appliances such as A/C, and store the vehicle until the power battery SOC reaches 50% to 80%.
- When the vehicle is used for the first time after it is parked for a long time (more than two weeks), please confirm whether there is any alarm in the instrument cluster. If there is any alarm, please contact a Farizon Auto after-sales service station for maintenance as soon as possible.

Noise and vibration

When the electric vehicles are used, you will hear or feel noise and vibration different from those of traditional fuel vehicles. The following noises and vibrations are normal:

- Noise of drive motor and rear axle reducer during operation.
- Noise of compressor and cooling fan of A/C in operation.
- Noise and vibration of relay opening and closing when the HV system is opened and closed.
- The sound of pedestrian warning system when the vehicle is running at low speed.
- Noise of water pump and cooling fan during charging.

Gearshift operation

Shift information

The gearshift device of this vehicle is knob type, which can be rotated clockwise/counterclockwise to switch gears. There are 3 gears, namely drive (D), neutral (N) and reverse (R).

- ⚠ Before gear shifting, the vehicle needs to be in READY status and confirm that the "READY" indicator on the instrument panel illuminates; when the gear shifting operation is wrong, the gear display icon of the instrument cluster will flash 3 times with 1 prompt sound. ◀



1. D - forward gear
2. N - neutral
3. R - reverse

Neutral (N)

When the vehicle is in this gear, the drive motor cannot output power, and the gearbox will not assist parking.

When the vehicle is stationary and started, depress the brake pedal and turn the gear knob counterclockwise to shift from N position to R position. Rotate the knob once to reset to N position.

When the vehicle is stationary and started, depress the brake pedal and turn the gear knob clockwise to shift from N position to D position. Rotate the knob once to reset to N position.

- ⚠ For driving safety, please do not coast in neutral.

The current gear information will be displayed on the instrument cluster. ◀

D (Drive)

This gear is used for normal running of the vehicle.

When the vehicle is in D position, if the brake pedal and handbrake are released, the vehicle will start creeping. The creeping speed is lower than 5km/h.

To shift from D to R, park the vehicle steadily and then switch to R.

 It is forbidden to shift from D position to R position before the vehicle stops steadily. When the gearshift operation is wrong, the gear display icon on the instrument cluster will flash 3 times with 1 prompt sound. ◀

 If the road slope is steep, the vehicle may not creep or even move backward. ◀

Reversing (R)

This gear is the position where the vehicle runs backward.

To shift from R to D, park the vehicle steadily and then switch to D.

 It is forbidden to shift from R position to D position before the vehicle stops steadily. When the gearshift operation is wrong, the instrument cluster gear display icon will flash 3 times with 1 prompt sound. ◀

When the electronic gear selector is in reverse (R), if the brake pedal is released, the vehicle will also start creeping at a speed lower than 5 km/h.

Driving mode

The vehicle has 3 driving modes: ECO (Economy) mode, POWER mode and normal mode. The normal mode is the default mode of vehicle driving.

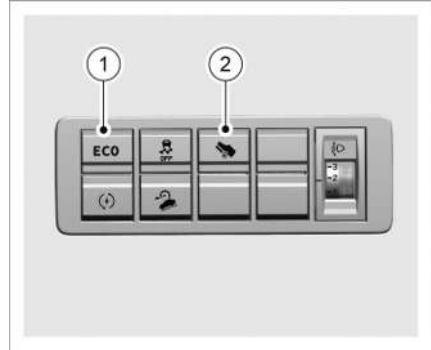

1. ECO mode button

2. POWER mode button

The ECO mode is the Ecology & Conservation & Optimization mode, in which the vehicle has good economy performance and high endurance. Press the ECO switch on the left side of the instrument panel to enter the ECO mode, and press it again to exit.

POWER mode: Press this button to turn on the POWER mode. At this time, the vehicle can break through the maximum speed limit of normal mode and drive at a higher speed. In this mode, the driving range will be relatively shortened.

 When the vehicle enters ECO (Economy) mode or POWER mode, the corresponding indicator on the instrument cluster will illuminate. ◀

Limp mode

When the vehicle has some specific faults, the power of the vehicle will be limited. The power limit status indicator  on the instrument cluster will illuminate, the maximum vehicle speed that can be reached will decrease, and the acceleration performance will also decrease.

Brake and assist systems

Service brake

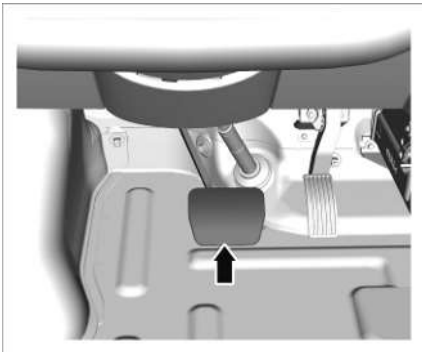

Braking operation includes sensing time and reaction time. The time of making the decision of stepping on the brake pedal is the sensing time. The time of actually lifting the foot and depressing the pedal is the reaction time. The average reaction time is about 0.75 seconds. But this is only the average value. The reaction time of a certain driver may be shorter, and the reaction time of some drivers may be as long as 2~3 seconds or longer. The reaction time is affected by age, physical condition, vigilance, coordination and vision.

Alcohol, drugs and depression can also have an impact. However, even if the reaction time is 0.75 seconds, a car traveling at 100 km/h will run 20 meters during such time. In an emergency, it will be a long distance. Therefore, it is important to keep enough distance from other vehicles. Of course, the actual braking distance can vary greatly as factors such as the road (highway or sandy road), road condition (wet, dry or icy), tread pattern, brake status, vehicle weight and the applied brake force vary. Unnecessary emergency braking should be avoided. Some people tend to make sudden operations during driving, accelerating suddenly and then braking urgently instead of keeping pace with the traffic flow. This is wrong. The brake may have no time to cool down between several emergency stops. If you depress the brake pedal frequently, it will accelerate the wear of the brake. If you drive at a speed consistent with that of the traffic flow and keep a certain distance between vehicles, unnecessary braking will be greatly reduced. This means better braking effect and longer service life of the brake. Adding non-original accessories will affect the performance of your vehicle.

Emergency brake reminder

When the vehicle performs emergency braking, the hazard warning lamp will flash at a certain frequency to remind the rear vehicle

that it is performing emergency braking. Please pay attention to keeping distance between vehicles.

 In winter, the ice and snow on the brake system will affect the braking performance. Please clean them in time. ◀

 When the brake pedal is depressed, if there is sharp metal friction sound at the vehicle brake, check whether the brake pad has worn to the minimum thickness in time. If the brake pad is worn to the minimum thickness, replace it immediately to ensure driving safety. ◀

 Do not put your foot on the brake pedal during driving. Otherwise, the brake components will be worn and overheated, and the braking distance will be increased. ◀

Mechanical parking brake

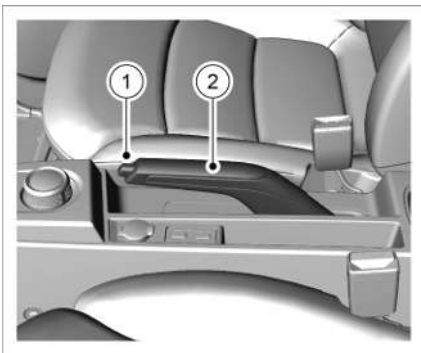

1. Parking brake button
2. Parking brake handle

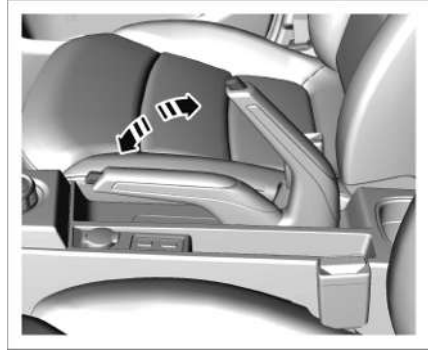

Pull up the parking brake handle (about 6~10 teeth) to apply the parking brake; press the parking brake button, pull up the parking brake handle slightly, and then fully release the parking brake handle to release the parking brake.

 Be sure to tighten the parking brake handle firmly and do not operate the release button. When driving on a slope, tighten it as much as possible and place a stop block at the wheel.

When the mechanical parking brake handle has been pulled up and the start switch is turned on, the parking brake indicator will illuminate.

To prevent the vehicle from moving accidentally, please be sure to pull tight the parking brake handle each time after the vehicle is parked fully.

When releasing the parking brake, be sure to fully release the parking brake handle. Otherwise, the parking brake

handle which is not released completely will cause overheat of the braking parts and affect the braking performance, leading to premature wear of brake pad and brake lining. ◀

Electronic stability control system (ESC)

The ESC can help you improve the vehicle body stability under severe driving conditions. When the controller detects that your desired driving status deviates from the actual body status, the ESC will start to work. The ESC will selectively apply braking pressure to the vehicle brake to improve the driving stability of the vehicle. When the ESC works, the ESC

indicator  will flash on the instrument cluster. When ESC or ABS works, you may hear some noises or feel the vibration of brake pedal. This is a normal phenomenon. When the

ESC indicator  is normally on, it indicates that there is a fault in the system and some functions will not work normally. In this case, please contact a Farizon Auto after-sales service station for troubleshooting. The ESC will be turned on automatically when the vehicle is started. In order to maintain the stability of vehicle control during driving, the system shall always be turned on.

 All four wheels must be equipped with tires of the same

model and specification. Different tires may reduce the stability of vehicle control, and ESC system may also fail. ◀

When you need to turn off the ESC system under special circumstances,

press the ESC OFF button  on the instrument cluster switch set to turn off the system. At this time, the ESC

OFF indicator  on the instrument cluster will illuminate.

It is recommended not to turn off the function as ESC is helpful for the vehicle body stability. It is recommended to shut down the system only in some special cases. For example:

- When driving with tyre chain;
- When driving in deep snow or on soft ground;
- The vehicle is stuck somewhere (e.g. in a muddy road).
- It is recommended to enable the ESC function immediately after the above driving conditions are over.

Anti-lock brake system (ABS)

ABS is a system that prevents wheels from locking during emergency braking or braking on slippery roads. The system adjusts the brake line pressure by detecting the speed of each wheel to prevent sideslip caused by wheel locking. By avoiding wheel locking, the vehicle will not lose steering ability during emergency braking and the sideslip of the vehicle

will be minimized when braking on a slippery road.

Use of the anti-lock brake function

In case of emergency braking, just press the brake pedal firmly to make the ABS work. You may hear the sound of the anti-lock brake pump or motor working and feel the pulsation of the brake pedal, but this is normal.

 ABS is helpful to better control the vehicle when braking on a slippery road. However, it cannot prevent accidents caused by careless or dangerous driving and the driver must drive carefully.

Even if ABS is used, the braking distance on slippery roads will be much longer than that on ordinary roads. Even if tire chains are used on rough sand roads or snow roads, the braking distance will be very long. Always keep a safe distance from the front vehicles, and the driver should maintain high safety awareness. ◀

Recommendations and precautions for driving

1. Even if your vehicle is equipped with ABS, keep a sufficient distance from the front vehicle. Compared with vehicle not equipped with ABS, your vehicle requires longer braking distance

in case of the following conditions:

- When running on sandy or icy and snowy roads;
- When tyres are installed with tire chains;
- When drive on pitted and uneven roads;
- When drive on bumpy road or bad roads.

2. In case of emergency, fully depress the brake pedal to activate ABS. At this time, you will feel the vibration of the brake pedal and hear a specific sound. Meanwhile, you will also feel the rebounding of the brake pedal. Please do not release the brake pedal until it is no longer needed.
3. ABS can also prevent the tires from being locked on some roads where it is difficult for the tires to grip. Road with pit, road paved with steel plates for construction, steps and other roads with height difference.
4. During emergency braking, you need to act quickly and depress the brake pedal with full force to allow the ABS and brake-assist device to work.
5. Please do not depress the brake pedal in repeated times and with slight force during emergency braking, otherwise braking distance will extend.

6. When the critical value of tire locking is exceeded or when driving at high speed in rainy days, a water film forms between the tire and the road surface. In case of loss of road gripping force, the ABS will not work.

Electronic brakeforce distribution system (EBD)

The EBD can automatically adjust the braking force distribution ratio of front and rear axles to improve braking efficiency, and cooperate with ABS to improve braking stability, thus ensuring smooth driving.

The EBD is an additional auxiliary function of ABS system, and it can improve the effectiveness of ABS. The EBD works during minor braking, especially during turning. The EBD function ensures high lateral force and reasonable braking force distribution.

Even if the ABS function of the vehicle fails, the EBD can ensure that there will be no serious accidents such as rollover caused by wheel locking. At the same time, the EBD can also greatly reduce the vibration and noise during ABS operation.

-  Please do not rely too much on the EBD function. Nonstandard driving action will easily lead to accidents. The vehicle speed shall be controlled to ensure effective distance and safe driving. ◀

Brake assist system (BAS)

Most drivers can brake in time under dangerous conditions, but they do not depress the brake pedal with enough force, so that the braking system does not generate maximum braking force, resulting in an increase in braking stroke. During emergency braking, the BAS will increase the driver's braking force and shorten the braking distance.

-  The BAS can only help the driver increase the braking force, but it does not mean that accidents can be avoided. Therefore, attention should be paid to keeping distance and driving carefully at any time. ◀

Traction Control System (TCS)

TCS is used to prevent the loss of traction on driving wheels. After the system detects that the driving wheel slips, it will reduce the torque output and apply brake to the idling driving wheel, and at the same time to prevent the driving wheel from slipping.

Vehicle dynamics control system (VDC)

The VDC will actively intervene to reduce the torque output when various conditions occur on under-steering, over-steering or slippery roads. At the same time, brake control is carried out for individual wheels purposefully and vehicles are finally guided to normal running

tracks, thus avoiding danger caused by vehicle loss of control.

Hydraulic brake boost system (HBB)

When the vacuum degree sensor determines that the vacuum is not enough, simulate the booster input and output force to actively pressurize for braking compensation and shorten the braking distance.

Hill hold control (HHC)

When the driver starts on a slope and releases the brake pedal, the HHC can maintain the braking force for about two seconds to effectively avoid rolling.

 The HHC function can only be activated when the ESC is turned on and the parking brake is fully released.

The HHC function is only a short-term pressure holding when the driver releases the brake pedal. If the accelerator pedal is not depressed or the parking brake is activated, the vehicle may slide on the slope after 2 seconds, so you should drive carefully when starting on a slope! ◀

Hill descent control (HDC)

The HDC function is mainly used to help the driver maintain a stable downhill speed through active braking, without the need for the driver to depress the brake pedal.

Activation and deactivation

Press the HDC button  on the instrument cluster switch set to activate the HDC function. At this time, the HDC green indicator on the instrument cluster will illuminate. Press this button again to deactivate the HDC function, and the instrument cluster indicator will go out.

 HDC only plays an auxiliary role. At all times the driver should be responsible for the safety of the vehicle, and always pay attention to the surrounding traffic conditions.

When the slope is too steep, HDC may not be able to keep the vehicle running down the slope at even speed. In this case, you can control the vehicle speed by depressing the brake pedal. ◀

 The function can only be activated when the vehicle speed is 30~60 km/h. When the vehicle speed is greater than 60 km/h, the function will exit automatically.

When HDC works, the green indicator on the instrument cluster starts to flash. When the HDC indicator is yellow, it indicates that there is a fault in the system. ◀

Roll movement intervention system (RMI)

The RMI function is mainly used to prevent the vehicle from rolling over

under high dynamic driving conditions. When the vehicle has a tendency to roll over, RMI reduces the lateral acceleration of the vehicle through active braking, thus avoiding rollover.

Parking assist system

Reversing radar system



The reversing radar system is automatically turned on after the driver shifts to reverse gear (R) to avoid collision with obstacles during parking.

The reversing radar sensor at the rear of the vehicle can detect objects up to 1.5m behind the vehicle.

 However, the ultrasonic parking assist system cannot replace visual detection by the driver. It may not detect:

- Objects under the vehicle, or objects that are too close to or far from the vehicle.
- Children, pedestrians, cyclists or pets.

- Very tiny objects may not be detected.

If you fail to pay attention to the situation behind the vehicle before or during reversing, it may lead to vehicle damage, personal injury and even death. Even if the parking assist system is equipped, the driver must observe carefully before reversing. During reversing, you must observe whether there are obstacles and pay attention to the rearview mirror of the vehicle. ◀

System operation

After the vehicle is shifted to reverse gear (R), the reversing radar system will be turned on automatically. When the vehicle exits reverse gear (R), the system will automatically shut down.

The reversing radar system cannot be activated until the reverse gear (R) is engaged. When the system is working, if an obstacle enters the detection range, the buzzer of vehicle instrument will prompt that there are obstacles behind the vehicle. The closer the vehicle gets to the obstacle, the faster the buzzer sounds. When the distance between obstacles is less than 30 cm, a continuous sound alarm will be heard. In hot or humid weather, the distance of detecting objects may decrease.

Distance from obstacle	Alarm frequency
70cm~150cm	Intermittent sound
30cm~70cm	Intermittent rapid sound
<30cm	Continuous sound

The system may not give an alarm.

Please note that the rear reversing radar system sensor may not give an alarm in the following cases:

- Mesh objects such as wires, cables and fences cannot be detected by the parking assist system.
- Low objects such as rocks and wooden blocks cannot be detected by the parking assist system.
- Soft snow, cotton, sponge and other objects that absorb ultrasonic waves easily cannot be detected by the parking assist system.
- The reversing radar system sensor may not be able to detect some obstacles with special shapes, such as pillars, small trees, bicycles, angles, corner stones, corrugated paper and other materials.

Possible false alarm of the system

Please note that the rear reversing radar system sensor may give false alarms in the following cases:

- When the surface of the reversing radar sensor is frozen, the reversing radar system may generate false alarms.
- When the surface of the reversing radar sensor is dirty, the reversing radar system may generate false alarms.
- When the vehicle is on a steep slope, the reversing radar system may generate false alarms.
- When a high-frequency radio or antenna is installed on the vehicle or used in a nearby place, reversing radar system may generate false alarms.
- If the horn sound, engine roar, emission sound, and other sounds of other vehicles are too close to the reversing radar sensor, the reversing radar system may generate false alarms.
- When you are driving in snowy or rainy weather, the reversing radar system may generate false alarms. If the vehicle approaches an obstacle, and the system does not give an alarm, first confirm whether this is caused by hot weather, cold weather or parking for a long time. When you have confirmed that the above conditions do not exist, please contact a Farizon Auto after-sales service station for check and repair.



When there are several obstacles, the parking assist

system sensor only detects the nearest obstacle. When the vehicle is moving, please note whether the reversing radar sensor on the other side has detected other obstacles. ◀

 Do not wash the sensors by spraying high-pressure water on them directly with equipment such as water guns, and do not squeeze or impact the sensor surface of parking assist system in other ways. Otherwise, the sensors may fail. ◀

Reversing image

The reversing visual system assists the driver in reversing by displaying a picture behind the vehicle.

 The driver must carefully observe whether there are obstacles around the vehicle before reversing, otherwise it may cause casualties and property losses. The reversing visual system cannot replace the driver's visual detection. Please do not rely only on it to reverse.

- The reversing camera cannot detect objects outside the visual range of the camera, such as those under the bumper or vehicle.
- The reversing camera system can only be used as a reverse assist system and cannot replace the driver's objective analysis of obstacles.

- It is forbidden to use the reversing visual system in long-distance and fast reverse operation or where there are lateral passing vehicles.
- The reversing camera will enlarge and distort the field of view. The image displayed on the display screen may be different from or cannot accurately reflect the real object, and there are differences between the distance displayed on the display screen and the actual distance.
- The reversing camera will be blurred due to the influence of ice, snow, mud and other sundries. Please keep the camera clean at any time.
- In extreme weather, such as strong light, rain and snow may affect the display effect of rearview mirrors and reversing image. Please adjust the vehicle speed and driving mode. ◀

Function on and off

The reversing image will be turned on automatically when the vehicle is shifted to reverse gear (R); it will be turned off automatically after the vehicle exits reverse gear.

Location of reversing camera

The reversing camera is installed on the high-mounted brake lamp. The

working range of the rear view camera is very limited and it cannot capture objects near the corner or under the bumper. The displayed image may vary depending on the direction of the vehicle or the road condition. The distance displayed on the screen is different from the actual distance.

Reversing assist line

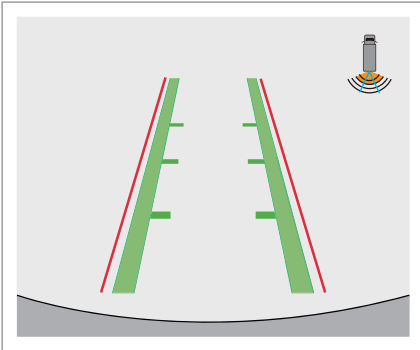

The dynamic auxiliary line of the reversing image of this vehicle, and the system will judge the driving track according to the wheel steering. The lines on both sides of the auxiliary line are the expected driving trajectories of wheels on both sides calculated by the system. The three auxiliary lines of reversing image indicate that the distances between obstacles and rear bumper are about 0.5m, 1m and 1.5m respectively.

i There is a difference between the distance displayed on the display screen and the actual distance. During reversing, always observe the

surroundings to ensure driving safety. ◀

Intelligent driving system

Acoustic vehicle alerting system

This vehicle is equipped with a low-speed warning system. When the vehicle runs forward and its speed is lower than 21 km/h, there will be sound to prompt pedestrians and other vehicles; when the vehicle is shifted to reverse gear (R), there will also be sound to prompt pedestrians and other vehicles.

- i** When the vehicle is moving forward with a speed of more than 1 km/h, the low-speed alarm function will be activated; when the speed is between 1 km/h and 21 km/h, the higher the speed, the stronger the warning tone; when the speed is greater than 21 km/h, the system will automatically turn off. ◀
- i** The low-speed alarm function is enabled by default. ◀

Loading

Cargo car body

Loading of goods

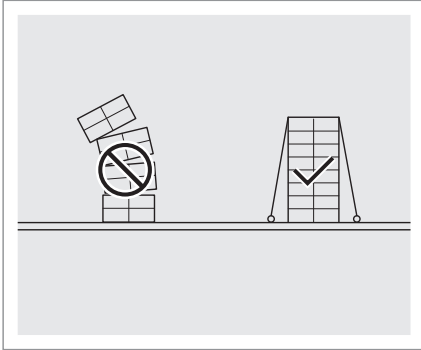

The goods in the cargo compartment shall:

- The articles shall be placed stably and fixed.
- Ensure that the weight is evenly distributed, and it is forbidden to be too heavy on one side
- Ensure the average height, and do not make one side too high

 Please pay attention to protecting your head when loading and unloading goods at the tailgate, as there may be a risk of collision due to negligence.

In case of emergency braking or steering, or collision, the articles in the cargo compartment may roll over or collide with each other, causing damage to the goods.

If the length or volume of the cargo exceeds the capacity of the cargo compartment, please replace it with another suitable vehicle for transportation. Do not transport oversized and overlength goods that will cause failure to close cargo compartment, which may cause serious accidents.

It is strictly prohibited to load flammable, explosive and other dangerous goods, or hazardous chemicals that are easy to corrode and volatile. Please know the local traffic regulations when loading special items. ◀

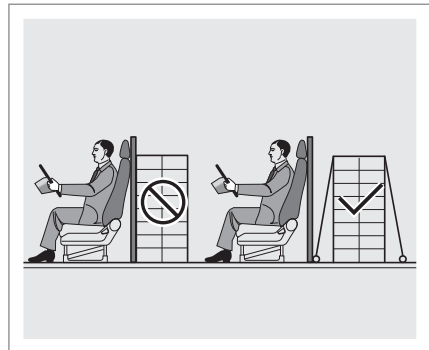

The cargo compartment partition of this vehicle meets the protection strength requirements of relevant regulations and standards, but it does not exclude that protection failure will occur under special circumstances. Therefore, the precautions in this chapter shall be followed when loading goods to ensure that the size and weight of

loaded goods are appropriate and fixed firmly.

- ⚠ If the above matters are not followed, the cargo may break through the cargo compartment shield due to inertial forward movement during emergency braking or traffic accident, causing serious injury or even death to front cabin passengers and driver. ◀

Easy to load

There are 4 lashing rings in the cargo compartment, which can be used to fix goods when necessary.

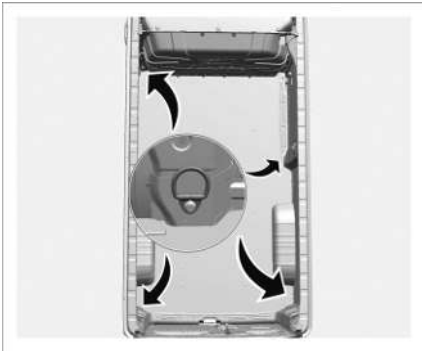

The tailgate limit lever can be used to load goods conveniently.

Open the tailgate, disengage the limit lever and support it at the supporting point of the tailgate frame.

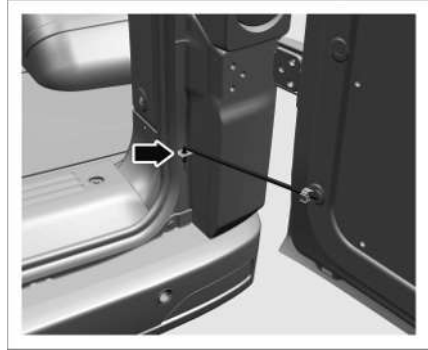

- ⚠ When opening or closing the rear tailgate, please ensure that the surrounding area is safe.

After opening the tailgate, please manually support the limit lever. Otherwise, it may be closed again suddenly after being opened.

Be careful to open or close the boot lid in windy weather, because it may be moved by the strong wind. If the tailgate is not fully opened (the limit lever is not properly supported), it may suddenly close. It is more difficult to open or close the boot lid on a slope than on a horizontal ground, so be careful that the boot lid opens or closes accidentally. Please use it when the tailgate is fully opened and fixed. ◀

- ⚠ If someone is nearby, it will be opened or closed after ensuring its safety.

Be careful not to pinch fingers when closing the boot lid.

Always pay attention to the status of the tailgate to prevent crushing risk or other personal injury caused by sudden closing of the tailgate. ◀

Tailgate open by 270°

For the vehicle equipped with a tailgate opening of 270°, a stop block is installed on the tailgate and side wall respectively. The stop block is a magnetic device that fixes the door by mutual suction.

 Do not put any object that is easy to be demagnetized and fails near the stop block, such as ID card, bank card and mobile phone.

Please pay attention to cleaning up the sundries adsorbed on the stop block, so as to prevent accidental closing due to insufficient suction of the tailgate.

Pay attention to the tailgate status at all times in windy weather, because it may exceed the suction force of the stop block due to strong wind and cause the tailgate to close suddenly. If necessary, fix the tailgate with other objects. ◀

Hazard warning device

Hazard warning lamp



Press the hazard warning lamp switch. At this time, the instrument cluster indicator and the exterior turn signal will flash at the same time to warn other road users; press the hazard warning lamp switch again to turn off the hazard warning lamp.

If the turn signal is operated when the hazard warning lamp is turned on, it will work first. After the turn signal is turned off, the hazard warning lamp continues to work. In order to reduce the risk of an accident, the hazard warning lamp must be turned on when necessary. Examples include the following:

- The vehicle breaks down due to technical failure.
- The vehicle is at the end of the vehicle when there is a traffic jam.
- In case of emergency.
- The vehicle is towing another vehicle or being towed.

i If the turn signal on one side of the instrument cluster flashes about twice faster than usual, it indicates that a turn signal lamp on the corresponding side fails. Please replace the bulb. ◀

Warning triangle

On conventional roads, warning triangles shall be placed 50 m to 100 m behind the vehicle; on expressways, warning triangles shall be placed 150 m away from the rear of the vehicle. In case of rain and fog, the distance shall be increased to 200 m.

The warning triangle is placed behind the driver's seat.



Jump start

Vehicle jump start

If the low-voltage battery is exhausted, try to start your vehicle with another vehicle and jumper cable. Be sure to follow the following steps to ensure safety.

Operation sequence for jump start of two vehicles:

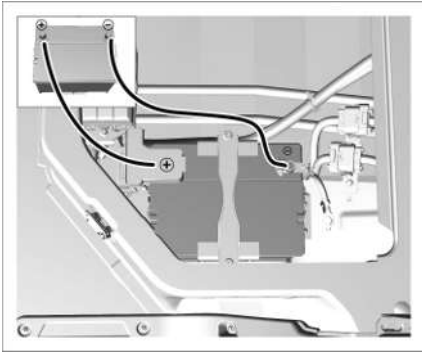

1. Turn off the Start switch (in LOCK/OFF position), and turn off all lamps and electrical accessories of both vehicles, except for hazard warning lamps (if necessary).
2. Open the driver's seat. Open the positive protective cover and connect the positive clip of jumper cable to the positive pole (+) of battery on this vehicle.
3. Connect the clip at the other end of the positive terminal of jumper cable to the positive (+) terminal of power supply vehicle battery.
4. Connect the negative clip of jumper cable to the negative pole (-) of power supply vehicle battery.
5. Connect the clip at the other end of the jumper cable negative terminal to the battery negative terminal (-) of this vehicle.
6. Connect the battery connection clip firmly, and try to start the

vehicle with dead battery. If the vehicle cannot enter READY mode, it is likely that there will be a fault and need to be repaired. Please contact a Farizon Auto after-sales service station for maintenance.

-  If the jumper cables are connected or removed in the wrong order, an electrical short circuit may occur and the vehicle may be damaged. The resulting repairs are not covered by the warranty. Therefore, it is necessary to connect or disassemble the jumper cables in the correct order, and ensure that the cables do not touch each other or other metals. ◀

Operation sequence for disconnecting jumper cables of two vehicles:

1. Disconnect the black negative (D) cable on the vehicle with a dead low-voltage battery.
 2. Disconnect the black negative (C) cable on the vehicle with a low-voltage battery with electricity.
 3. Disconnect the red positive (B) cable on the vehicle with a low-voltage battery with electricity.
 4. Disconnect the red positive (A) cable on vehicles with a dead low-voltage battery.
-  The rated voltage of the power supply battery during jump starting shall be 12V, and its

capacity shall not be less than that of the battery to be charged.

The battery has an intelligent charging function. If the power battery is fully charged but too low or exhausted, it indicates that the battery may have been damaged.

Please contact a Farizon Auto after-sales service station in time. If the vehicle cannot be started normally due to low power battery, please charge the vehicle in time. ◀

 In order to prevent short circuit when jump starting a vehicle, jumper cable clips must not contact each other or any conductive material other than their corresponding battery terminals.

When you need to help another vehicle with jump start, be careful not to move moving parts when connecting the jumper cable.

Only jumper cables that are thick enough shall be used, and attention shall be paid to the data information given by the manufacturer of the jumper cable. ◀

 Improper use of low-voltage batteries can cause personal injury. Low-voltage batteries are dangerous because:

- The batteries contain acid which may cause you to get burnt.
- The gases inside the batteries are explosive or combustible.
- You may get burnt due to the electric quantity contained in the batteries. ◀

Traction and towing of vehicles

Vehicle transportation

To tow the vehicle off the road, please put the electronic gear selector in neutral (N), place the vehicle on the trailer, pull up the hand brake, turn off the power supply of the vehicle and turn on the hazard warning lamp.

Use safe chain system for towing, and obey national and local laws. It is recommended to use a wheel-lift trailer or platform trailer. Wheels and axles in contact with the ground must be in good condition. If they have been damaged, use a flatbed trailer.

This vehicle is a pure electric vehicle and adopts rear-wheel drive. You can tow the vehicle in the following ways:

1. Use a flatbed trailer to transport the vehicle, which is the best way to transport the vehicle.

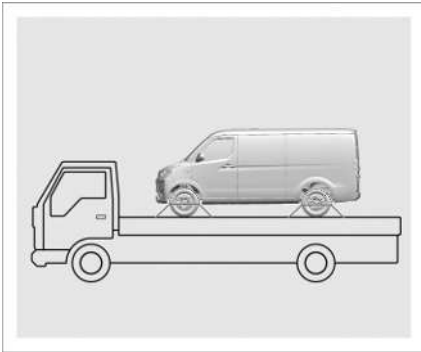

2. When a wheel-lift trailer is used for towing from the front of the vehicle, the towing trolley must be used under the rear wheels and the parking brake must be applied. If the towing trolley is not used, the drive motor controller may be damaged.

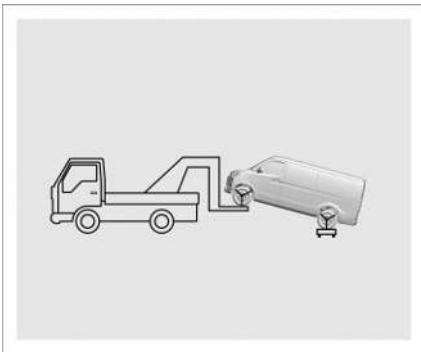

3. When a wheel-lift trailer is used for towing from the rear of the vehicle, the parking brake must be applied. If conditions permit, the front wheels may not use the towing trolley, but the steering column must be unlocked.

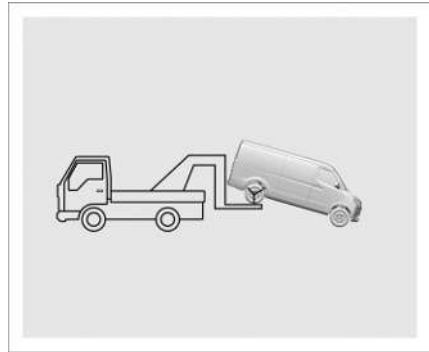

4. Do not tow the vehicle by lifting.

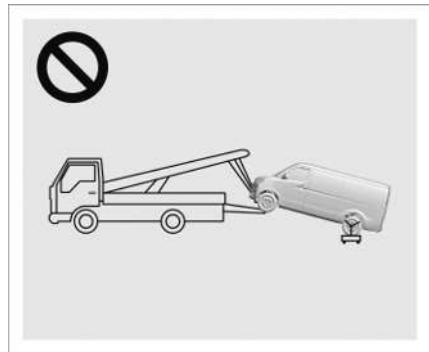

-  In case of a failure to tow the vehicle with a wheel-lifted truck or a platform truck, use a rigid connection to temporarily tow the vehicle to a safe area, and wait for help.

Avoid towing the vehicle for a long distance or at a speed over 5 km/h when a rigid connection is applied ◀

-  When lifting the vehicle, sufficient ground clearance must be ensured for the on-the-ground end of the vehicle, or the vehicle may be damaged during the traction. ◀

⚠ If soft connection towing device (for example, pulling rope) is used, please ensure that the distance between the towing vehicle and the towed vehicle is greater than 4 m but less than 10 m. To tow a vehicle with braking failure, please use hard connection towing device (for example, tow bar) to tow the faulty vehicle. ◀

⚠ The hazard warning lamps shall be turned on during towing of both the tractor and the towed vehicle. ◀

⚠ The vehicle should be towed away from the site only after ensuring no safety risk to the vehicle. If the vehicle battery pack is deformed, leaking or smoking, the safety risks shall be solved first. ◀

Towing hook

Use of towing hook

1. Remove the front towing hook cover on the front bumper with an appropriate tool.

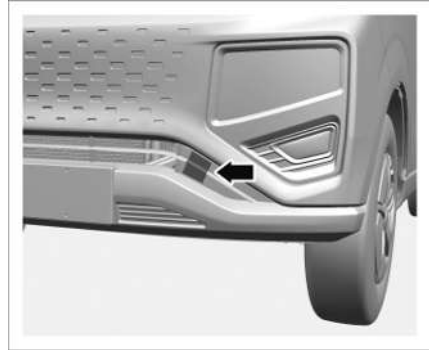

2. Screw the front towing hook into the threaded guide sleeve of the towing hook and tighten it.



⚠ It must be ensured that the front towing hook is fully tightened. ◀

⚠ Before towing, it must be confirmed that the towing rope has been sleeved into the towing hook and will not come off. During towing, the vehicle must be driven slowly and at a constant speed. It is forbidden to drive too fast, accelerate or decelerate rapidly. Excessive traction will damage the vehicle.

◀

Fuse replacement

Fuse location and identification

Fuses protect vehicle electrical equipment by preventing overload of electrical appliances in the circuit. A blown fuse indicates that the circuit it protects has failed and stopped working. If it is suspected that the fault is caused by fuse damage, take it out of the fuse box for inspection to see if the metal wire in the fuse is blown.

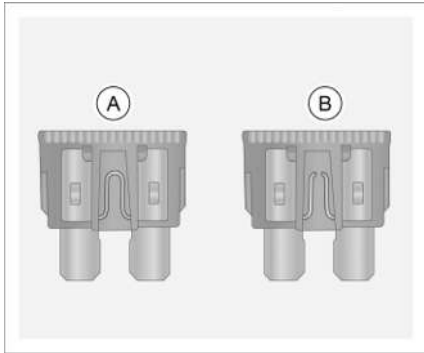

A - The fuse is intact

B - Fuse blown

The fuses are located in the instrument panel fuse box above the accelerator pedal and in the chassis fuse box below the driver's seat. There are altogether two different types of fuses:

1. Strip fuse - thin, plug-in, allowing the circuit to pass current of 5-25A.

2. Slow-blow fuse - square, plug-in type, allowing the circuit to pass current of 20-60A.

The colour represents the amperage of the fuse which is also marked on the fuse.

 For the blown fuse, please do not try to repair or use a fuse with a different color or amperage as a substitute; otherwise, the electrical system may be damaged or a fire may happen due to overload of the wires. ◀

Chassis fuse box

The chassis fuse box is located under the driver's seat and can be seen by lifting the driver's seat.

Press the lock tongue of fuse box cover and open it to check the fuse.

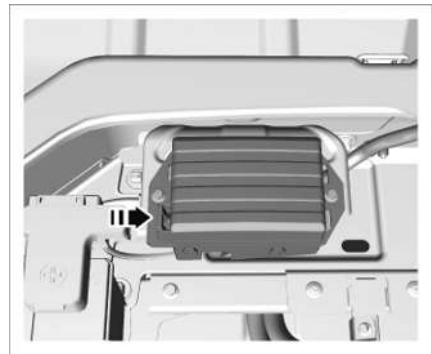

 After checking the fuse, be sure to cover the fuse box properly. If liquid splashes into the fuse box, it will cause short circuit and blow out the fuse or even cause fire. ◀

List of chassis fuses

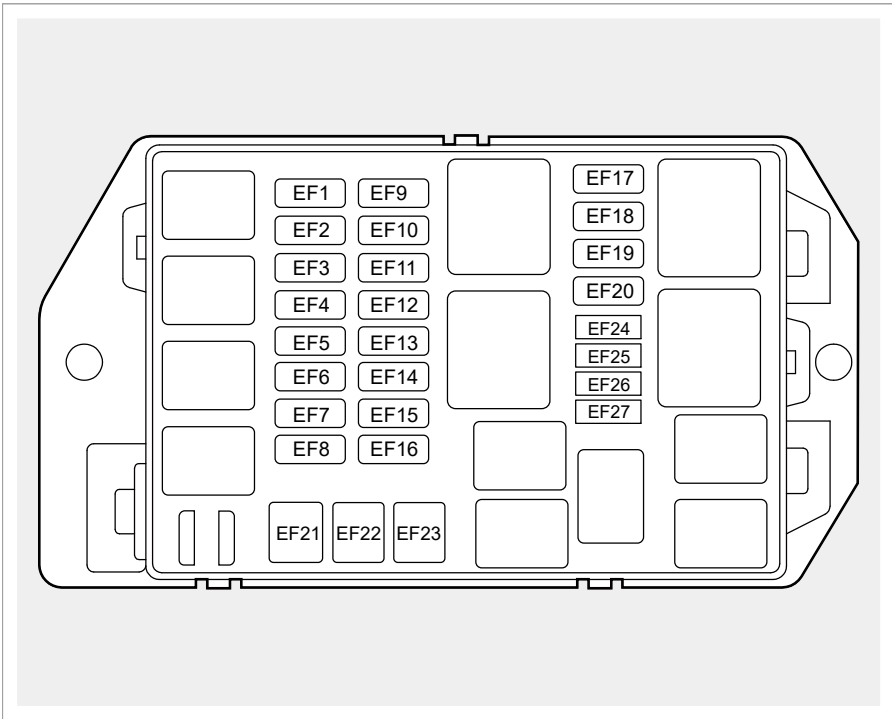

Fuse No.	Description	Amperage	Remarks
EF01	EVCC	5A	-
EF02	PMS	10A	-
EF03	HVC, MCU	10A	-
EF04	OBDD	10A	-
EF05	HU	15A	-
EF06	Brake switch	5A	-
EF07	LHVSM	20A	-
EF08	-	-	-
EF09	ESC control unit	30A	-
EF10	-	10A	-
EF11	-	-	-

Fuse No.	Description	Amperage	Remarks
EF12	-	-	-
EF13	-	-	-
EF14	-	-	-
EF15	-	-	-
EF16	-	-	-
EF17	PMS\EGSM	5A	-
EF18	HVC\MCU	5A	-
EF19	SRS	5A	-
EF20	VSM	10A	-
EF21	FAN	30A	-
EF22	ESC motor	40A	-
EF23	BCM	30A	-
EF24	Stand-by insurance	5A	-
EF25	Stand-by insurance	10A	-
EF26	Stand-by insurance	15A	-
EF27	Stand-by insurance	20A	-

Instrument fuse box

The instrument fuse box is located above the accelerator pedal. Press the lock tongue of the fuse box cover and open it to check the fuse.

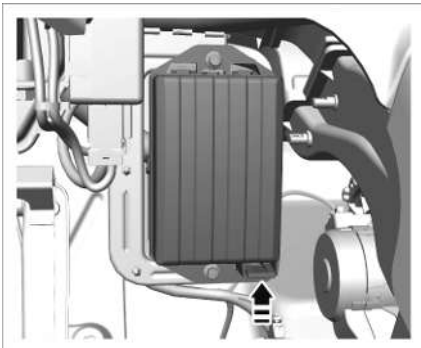

Instrument fuse list

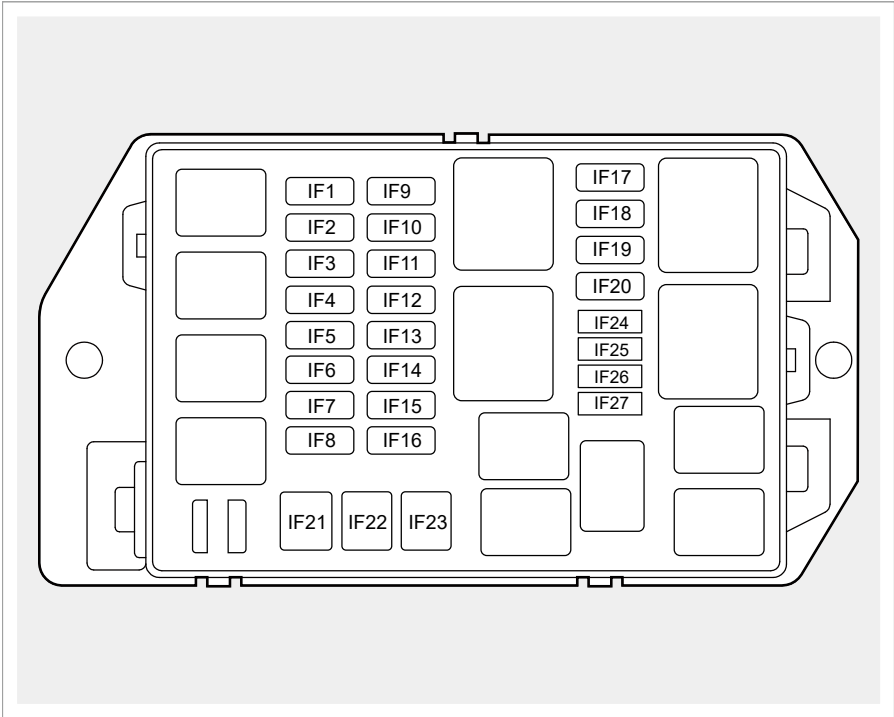

Fuse No.	Description	Amperage	Remarks
IF01	Turn light / ACCM	15A	-
IF02	BCM / Reading lamp	10A	-
IF03	IC / BMS	10A	-
IF04	Water pump	15A	-
IF05	High beam	15A	-
IF06	Lamplet / Low brake light	15A	-
IF07	Horn / Power mirrors*	10A	-
IF08	SWM	15A	-
IF09	Left low beam	10A	-
IF10	Right low beam	10A	-
IF11	START	5A	-

Fuse No.	Description	Amperage	Remarks
IF12	ESC / EPS / BMS / Brake switch	5A	-
IF13	Wiper washing	20A	-
IF14	Lighting power supply	10A	-
IF15	BCM / HU	5A	-
IF16	Emergency power supply / USB / Mirror adjustment sw*	15A	-
IF17	-	-	-
IF18	IC / AVAS	5A	-
IF19	BCM	5A	-
IF20	ACCM / AC / Console switch	5A	-
IF21	Ignition switch	30A	-
IF22	Vacuum pump	40A	-
IF23	Blower	30A	-
IF24	Stand-by insurance	5A	-
IF25	Stand-by insurance	10A	-
IF26	Stand-by insurance	15A	-
IF27	Stand-by insurance	20A	-

Check or replace the fuse

1. Strip Turn off the Start switch (to OFF position).
2. Clamp the fuse head with one end of the fuse removal tool and pull out the fuse. Check whether the metal wire is blown to identify whether the fuse is in good condition.



3. Replace the blown fuse with another new fuse of the same amperage. If the fuse is damaged

immediately after being replaced with a new one, it indicates that some part of the vehicle is faulty. Please contact a Farizon Auto after-sales service station for maintenance as soon as possible.

Lamp bulb replacement

Bulb specifications

Component Name	Bulb Name	Bulb model	Power (W)
Front combination light	High beam	H1	55
	Low beam	H1	55
	Front turn signal	PY21W	21
Front position lamp	Front position lamp	LED	3
Daytime running light	Daytime running light	LED	3
Rear combination lamp	Rear brake lamp / position lamp	P21/5W	21/5
	Reversing Lamp	P21W	21
	Rear fog lamp	P21W	21
	Rear turn signal	P21W	21
Side turn signal	Side turn signal	W5W	5
High-mounted brake light	High-mounted brake light	LED	2.4
Rear license plate light	Rear license plate light	W5W	5
Cab reading lamp	Cab reading lamp	LED	0.3
Cargo compartment lamp	Cargo compartment lamp	LED	0.3



Replacing bulbs usually requires dismantling certain vehicle parts, and requires professional skills to carry out relevant operations. For the bulb which can only be accessed from the front part of the vehicle, as

many high-temperature components and moving components are in the engine bay, it is more dangerous and more difficult to operate. Please contact a Farizon Auto after-sales service station for

maintenance and bulb replacement as soon as possible. ◀

 When the bulb is working, the bulb and connector may become very hot, and you may be burnt by these components when replacing the bulb. Therefore, these components should be allowed to cool sufficiently before operation. ◀

 After replacing the bulb, be sure to confirm that the bulb is installed firmly. ◀

Emergency response

Vehicle over-temperature

Vehicle overheating actually refers to excessively high temperature of coolant, power battery or drive motor:

- If the power battery fault warning lamp on the instrument cluster illuminates, it indicates that the power battery may overheat;
- If the drive motor fault warning lamp on the instrument cluster illuminates, it indicates that the drive motor may be overheated;
- If the electronic water pump fault warning lamp on the instrument cluster illuminates, it indicates that the coolant temperature is too high.

The following procedure shall be followed:

1. Drive the vehicle safely off the road to a safe place, then stop and turn on the hazard warning lamp, switch the gear to neutral (N), and pull up the parking brake. Make sure that the A/C system is turned off.
2. Check the radiator, hose and vehicle underneath for obvious coolant leakage. But it is normal that there are water drops coming from working A/C.
3. If the coolant leaks, stop using the vehicle immediately and notify a Farizon Auto after-sales service station or ask for help from a qualified repair shop.
4. If there is no obvious water leakage, check the coolant expansion tank. If the coolant expansion tank dries up, add coolant to about half of the tank when the vehicle is started.
5. If there is no coolant leakage and the coolant level in the expansion tank is normal, please contact a Farizon Auto service station for maintenance.
6. When coolant temperature drops to normal, check the coolant level in the expansion tank again. If necessary, add coolant to half of the tank. Serious coolant loss indicates system leakage. It must be checked by a Farizon Auto after-sales service station or qualified repair shop as soon as possible.

7. After parking in summer, the cooling fan often runs automatically, even for a long time, which is normal. After the temperature of the drive motor or motor controller drops to the working temperature and the cooling fan is no longer needed, the cooling fan will automatically turn off.

 If you need to open the expansion tank cover, do not operate until the cooling system cools down; otherwise, the cooling system in a high temperature status may cause scald. ◀

Vehicle collision

In case of vehicle collision (including front, rear, left and right collision and ground collision), the vehicle should be stopped immediately to evacuate passengers.

- If the vehicle control system powers off the high voltage system in case of a collision, the READY indicator will go out and the vehicle cannot continue to run. Please contact a Farizon Auto after-sales service station immediately.
- If the damage of the vehicle cannot be estimated, please do not touch the vehicle. Keep away from the vehicle, and immediately contact a Farizon Auto after-sales service station to inspect and repair the vehicle. Be sure to inform the emergency personnel who come to handle the accident without delay that the vehicle is an electric vehicle, and do not allow anyone to approach, touch or move the vehicle.
- Under any circumstances, it is forbidden for any person to repair the vehicle when the power supply of the vehicle is not completely disconnected.
- Check whether the HV components and wiring harnesses of the vehicle are damaged or exposed. To avoid personal injury, please do not touch the high-voltage wiring harness, connectors or other high-voltage components (motor controller, power battery, etc.). Do not touch the damaged or exposed wire harness to avoid high voltage electric shock. Especially, if the base plate of the vehicle scratches the ground, carefully check whether the high-voltage wiring harness distributed on the base plate is damaged. Wear insulating protective clothing (including insulating gloves, insulating shoes and insulating clothing) withstanding a voltage above 1,000V when you need to contact any high-voltage cables or components.
- If the driver and passengers are trapped, please try to cut the vehicle after confirmation by professionals. Do not touch HV

cables (the skin of HV cables is orange) during cutting.

- If the vehicle needs to be repaired or painted after an impact, it must be handled at a Farizon Auto after-sales service station. Dismantling the vehicle without permission is not allowed. Remove the power battery before painting. The risk of spontaneous combustion may occur when the power battery is exposed to a spraying operation room with higher temperature. In addition, if the power battery on the vehicle is not removed, it may bring potential safety hazards to maintenance personnel who have not been trained in electric vehicle maintenance.

Vehicle fire

In case of fire, stop the vehicle immediately, then turn off it, evacuate passengers and leave the vehicle quickly, and call the police according to the site conditions. Under the premise of keeping personnel safety, proceed as follows if possible:

1. In case of smoking and fire of low-voltage harness, use carbon dioxide or dry powder fire extinguisher.
2. If the battery catches fire, use a high-pressure water gun to put out the fire at a long distance.
3. If you accidentally inhale thick smoke, please move to a safe

area and seek medical attention as soon as possible.

4. Immediately contact a Farizon Auto after-sales service station for further advice on vehicle battery handling.



Leakage or damage of electrolyte of power battery may cause fire. If it happens, please contact a Farizon Auto after-sales service station immediately. Please do not touch the leaked electrolyte with your hands. If your skin or eyes contact the electrolyte, please rinse immediately with plenty of water and seek medical attention immediately to avoid injury. If the vehicle catches fire, please leave immediately. ◀

Getting vehicle out of trap

When the vehicle falls into snow, mud pit or other soft road surface, please refer to the following steps to get out:

1. Turn the steering wheel leftward and rightward to forge an unoccupied area surrounding the front wheels.
2. Drive the vehicle forward and backward for several times. Don't keep the wheels running at idle speed as possible. Gently step on the acceleration pedal.
3. If you still cannot get out of the trouble after several attempts, tow the vehicle.

 Before getting the vehicle out of trap, check whether there are people or obstacles around the vehicle, because the vehicle may suddenly move forward or backward during operation, causing damage. ◀

In order to prevent damages to the motor and other parts, avoid idling of the wheels as much as possible when a vehicle is trapped, pay attention to the speedometer, and the vehicle speed is not allowed to exceed 50 km/h or idle continuously for 30 seconds.

 If the wheels idle at a high speed, the tire may burst, causing injury to you or other passengers, and the drive motor or other parts of the wheel may overheat, resulting in fire or other damage to the front engine compartment. ◀

On-board tools

On-board tools

The following tools are placed behind the driver's seat.

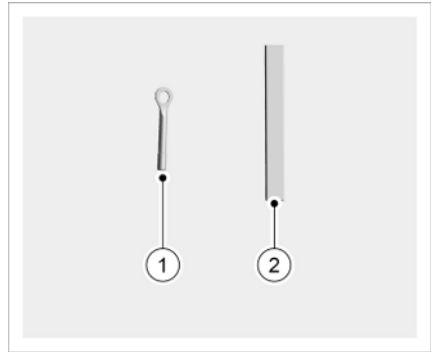

1. Towing hook
2. Warning triangle board

Maintenance

Regular maintenance

 The maintenance intervals, inspections, overhauls, and recommended fluids and lubricants specified in this manual are necessary for maintaining good vehicle condition. Any damage caused by failure to follow regular maintenance is not covered by the vehicle warranty. ◀

Proper vehicle maintenance is not only helpful to keep the vehicle in good condition, but also beneficial to the environment. All recommended maintenance items are very important. Incorrect oil level or incorrect tire pressure will increase the power consumption of the vehicle. In order to protect the environment and keep the vehicle in good condition, the vehicle must be properly maintained.

Maintenance scheme for use

As people use vehicles in various ways, their maintenance needs are different. You may need to check and replace more frequently.

If you have any questions about how to keep the vehicle in good condition, please consult a Farizon Auto after-sales service station. This maintenance plan is applicable to the following vehicles:

- Vehicles transporting passengers and goods within the specified loading range.
- Vehicles driving on suitable roads within the speed limits specified by laws and regulations.

 The vehicle maintenance operation is complicated and may be dangerous. Performing certain maintenance tasks by yourself may cause serious injury. Only when the driver has sufficient maintenance technical experience as well as necessary tools and equipment can he/she carry out maintenance by himself/herself. If you are not sure, please contact a Farizon Auto after-sales service station for maintenance. ◀

When repairing and maintaining the vehicle, use the correct fluid. Please refer to "Recommended Fluids and Capacity" [▶ 143] in Chapter 9 "Technical Data". Before driving the vehicle, the driver must check all relevant parts and complete all necessary repairs. We recommend using original parts provided by a Farizon Auto after-sales service station.

Maintenance records

Please refer to the Warranty and Maintenance Manual for details. After each maintenance, you must ask a Farizon Auto after-sales service station to sign and seal on the page of maintenance record form.

Maintenance by the owner

 In case of obvious or sudden drop in the fluid level, or uneven tire wear, contact a Farizon Auto after-sales service station for maintenance immediately. ◀

In addition to the maintenance mentioned above, the owner should also carry out some simple inspections frequently. Here are some suggestions for you.

Daily inspection

- Functions of lights, horns, wipers, scrubbers and hazard warning lamps.
- Functions of seat belts and brakes.
- Check the underbody for traces of liquid residue indicating leakage.
- Check tire appearance.

Weekly inspection

- Coolant level
- Windshield washer fluid level.
- Appearance of power battery
- Tire pressure and condition.
- Operation A/C system.

Front engine compartment

Front engine compartment

Open the engine compartment cover

1. Pull the engine hood opening handle at the driver's instrument

panel to pop up the front engine hood.



2. Put your hand into the gap of engine hood, pull the unlocking handle to the left and lift the engine hood at the same time to open it.

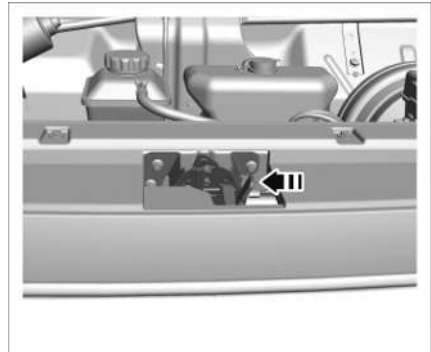

3. Open the engine hood, lift up the stay bar and insert it into the fixing pin hole of the stay bar.



⚠ When the vehicle fails in rain, do not open the engine compartment cover by yourself.

Make sure that the strut is inserted into the fixing pin hole to avoid danger of sudden falling of the engine hood due to unstable fixation of the bonnet strut. ◀

Close the engine compartment cover

1. Retract the strut and reset it.
2. Close the engine hood with force at a height of about 30 cm from the lock catch.
3. Check if the engine hood is secured in place.

⚠ Before closing the engine hood, make sure that there is no debris left inside the engine compartment.

Make sure that the engine hood is fully closed and secured before driving. Otherwise it may open unexpectedly during

vehicle running that leads to accident. ◀

Cooling system

Introduction to cooling system

The coolant system of the electric system ensures that the drive motor and HV auxiliary drive controller work at the most suitable temperature under all working conditions to avoid overheating of the electric system.

⚠ The coolant expansion tank pressure cap must be opened after the cooling system is completely cooled, otherwise there may be a risk of scald. ◀

⚠ Heater and radiator hoses, and other parts may be very hot. Do not touch these parts, otherwise you will be burned. Never run the vehicle in case of coolant leakage. If the vehicle runs, it may cause all the coolant to be lost. This will cause a fire and you may get burned. Therefore, all leakage parts should be repaired before driving. ◀

♻ Please dispose of used antifreeze according to relevant environmental protection laws. ◀

Check the coolant

Check the coolant

The electric system coolant expansion tank is located in the

middle of the front engine compartment.

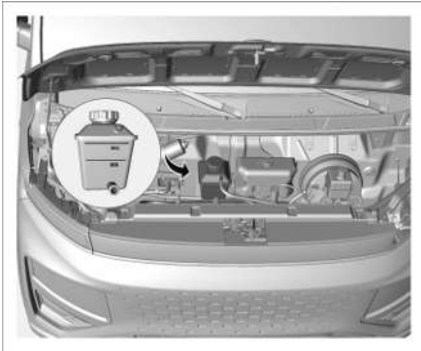

The vehicle must be parked on a flat ground when you detect the coolant level. Check whether the coolant level in the expansion tank is between MAX and MIN marks. If the coolant level is lower than the MIN mark, fill the expansion tank with coolant according to the specified procedure.

If the coolant level drops significantly in a short period of time, it means that there may be leakage in the cooling system. Please contact a Farizon Auto after-sales service station for maintenance as soon as possible.

Adding of coolant

1. Slowly rotate the pressure cap counterclockwise. If you hear a hissing sound, wait until the sound disappears before opening it. A hissing sound means that there is still pressure inside.

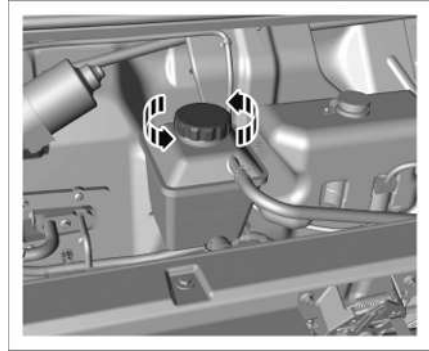

2. Continue to rotate the pressure cap and remove it.
3. Add appropriate amount of coolant to make the coolant level at the middle position between MAX and MN scales of expansion tank.



-  The coolant expansion tank pressure cap must be opened after the cooling system is completely cooled, otherwise there may be a risk of scald.

If the coolant splashes out, dry it with a dry cotton cloth after ensuring that the vehicle is powered off to avoid damaging

other parts or paint surfaces in the engine compartment.

Do not mix coolants of different brands and specifications. Different brands of coolants are added with different types of preservatives, rust inhibitors and other chemical components. When they are mixed with each other, chemical reactions will easily occur, causing precipitation, scaling, corrosion and other hazards, thus affecting the service life of the vehicle. ◀

Brake system

Precautions for Brake System

For a vehicle with good braking performance, no matter at any speed, it can quickly reduce the speed or stop in a short time and distance with the braking measure. Good braking efficiency plays an important role in improving the average speed of the vehicle and ensuring driving safety.

If the brake lining is worn, the vehicle cannot be braked effectively. The degree of wear on the brake lining mainly depends upon the vehicle operation conditions and driving habit. In case of frequent driving in urban areas or short-distance driving, it is recommended to increase the inspection frequency of brake lining thickness according to the

maintenance cycle specified in the Warranty and Maintenance Manual. Please refer to the maintenance interval specified in the Warranty and Maintenance Manual for replacement.

 Emergency braking should not be used when you are driving on narrow, slippery, frozen or muddy roads. After passing through the wading section, depress the brake pedal several times in succession to eliminate the moisture on the brake pads and make the brake recover well. ◀

 Please contact a Farizon Auto after-sales service station for maintenance as soon as possible to ensure the best braking effect and minimum wear between the brake lining and brake drum. The new brake lining does not have the best friction characteristics within the first 200 km to 300 km, so it must be run-in. At this stage, the braking effect decreases slightly, and can be compensated by increasing the pedal force of the brake pedal. After replacement, running-in also needs to be carried out for the new brake lining according to the above requirement. Do not drive too close to other vehicles or perform emergency braking. Be especially careful when driving with new tires and new brake

pads, so as to avoid the above situations and accidents. ◀

Brake pedal travel

If the brake pedal cannot be restored to normal height or its stroke is too large, please contact a Farizon Auto after-sales service station for maintenance as soon as possible. This may be a signal that the brake system needs maintenance.

Brake squeal

When the brake pedal is depressed, the front and rear brakes work at the same time. If there is occasional squeal sound during braking, it is a normal phenomenon caused by wet or cold road surface, rainy and snowy weather and other environmental factors. Especially in rainy and snowy days, it has a high probability of occurring at low temperature, low speed and the moment when braking is about to stop. This is an unavoidable normal phenomenon and will not affect the reliability of brake system. If there is continuous squeal sound during braking, it may be that the brake pad has been worn to the limit. Please contact a Farizon Auto after-sales service station for maintenance.

Brake creeping sound during starting

It is normal that the brake creeping sound occurs during starting, and friction noise between the brake lining and the brake drum can be heard when the brake is released.

Before starting, the electronic gear selector is turned to forward gear (D), and the power output pulls the vehicle to start moving forward. At this time, under the action of the brake, the vehicle remains stationary, and the braking torque is greater than the starting torque at this time. In this process, energy is accumulated at the brake. When the brake pedal is released, the energy accumulated at the brake is released, exciting a "creak" sound at the front wheels. The sound will be more obvious if the brake is stained with water after vehicle washing.

Sound of depressing the brake pedal in situ

When the vehicle is stationary, the wheels are rolling while turning the steering wheel. If the brake pedal is depressed at this time, the wheels will be prevented from rolling. Under the simultaneous action of steering force and braking force, the vehicle accumulates some energy, so that the brake lining and brake drum creep when they are clamped to release this part of energy. Therefore, the vehicle will produce a "creak" sound, which is normal and does not affect the performance and use of the vehicle.

Heating of brake lining after use

Braking is realized by friction between the brake drum and the friction lining, which is a process of converting kinetic energy into

thermal energy. Therefore, the heat is generated. And it is normal for brake lining to generate heat after braking.



-  Do not touch the brake disc with hands after parking to avoid scalding. ◀

Braking energy recovery

The brake system of the vehicle has an energy recovery function: When the vehicle is in forward gear (D), kinetic energy is converted into electric energy during braking or coasting, and the power battery is charged to feed back energy and improve the driving range. In the process of energy recovery, the wheels reversely drag the drive motor to rotate, and the drive motor and the service brake system jointly realize vehicle deceleration.

This function can be set by pressing the brake energy recovery button on the instrument panel switch block.

The energy recovery level must be set when the vehicle is in D gear. Press the button continuously to switch among three levels: L1, L2, and L3.

-  In order not to affect the driving feeling, L3 is recommended when the vehicle is fully loaded. ◀
-  It is normal to have slight stalling and motor noise when the vehicle decelerates. ◀
-  When the power battery is full and its temperature is too high or too low, the energy recovery

will be automatically reduced in order to prevent the battery from being damaged. ◀

Brake fluid

In the hydraulic brake system, if the brake fluid is too little or has not been replaced for a long time, it will affect the braking performance. Therefore, the brake fluid shall be added in time and replaced regularly.

-  When the brake fluid drops to a certain low level, the brake system failure warning indicator will light up. ◀

Check

The brake fluid reservoir is located on the right side of the engine compartment. Check whether the fluid level in the reservoir is between MIN and MAX.

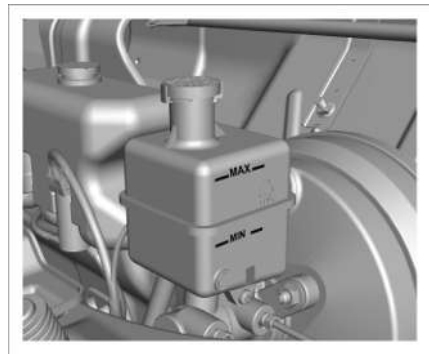



Filling

Unscrew the cover of fluid reservoir and pour brake fluid slowly to avoid overflowing. If the brake fluid overflows, remove it immediately with a dry cotton cloth. Otherwise, the spilled brake fluid may cause

damage components in the engine compartment.

Be sure to use the original brake fluid of Farizon Auto or equivalent products.

 Adding brake fluid cannot solve the leakage problem. If the brake fluid is still too little after a period of time after adding, please contact a Farizon Auto after-sales service station for maintenance as soon as possible. ◀

 If the brake fluid splashes on the paint surface of the vehicle, it will damage the painted surface. Pay attention to prevent the brake fluid from splashing onto the vehicle. If the vehicle is splashed, it must be cleaned immediately. ◀

 The water absorption of brake fluid is very strong. If the vehicle is used in an area with high atmospheric humidity for a long time, the frequency of replacing brake fluid shall be increased. ◀

Power steering

EPS

This vehicle is equipped with an electric power steering system, which consists of a DC motor, torque sensor, electronic control unit and booster mechanism. The hydraulic components of the traditional hydraulic power steering system are canceled. The electric power steering

system uses the latest electronic control technology and high-performance motor control technology, thus significantly improving the dynamic performance and static performance of vehicles, improving driver comfort and safety during driving, reducing environmental pollution, and effectively making up for the shortcomings of hydraulic power steering system in energy consumption and environmental protection.

The electric power steering system realizes the functions of electric follow-up assist and active return according to vehicle speed, steering wheel angle and torque acting on the steering wheel. The system can only work when the vehicle is started. When the vehicle is in "READY" mode, if the EPS malfunction indicator on the instrument cluster illuminates or lights up during driving, it indicates that the electric power steering system does not work normally.

 When you feel difficulty in steering, please contact a Farizon Auto after-sales service station for maintenance. ◀

Front combination light

Fogging in headlamp cluster

The headlamp cluster adopts ventilating design to adapt to the normal pressure changes in the lamp. Therefore, fogging is a natural phenomenon brought about by this

design. When water vapor enters the headlamp cluster through the vent, fogging may be caused if the outside air temperature is too low. When fogging occurs, a thin layer of water mist will be formed inside the lens of the headlamp cluster. Under normal operating conditions, the water mist in the headlamp cluster dissipates within half an hour after the high and low beams of the headlight are on.

The following conditions are acceptable:

- There is a thin layer of water mist (no streaks, drip mark or small water droplets).
- The water mist covers less than 50% of the lens of the headlamp cluster.

The following conditions are unacceptable (usually caused by water leakage from the front combination lamp):

- There is a puddle inside the front combination lamp.
- There are large areas of water droplets, drip marks or streaks inside the lens of the front combination lamp.

 If the above conditions are unacceptable, please go to a Farizon Auto after-sales service station for maintenance. ◀

Low-voltage battery

Utilization and maintenance of battery

This vehicle is equipped with a maintenance-free low voltage battery, which is located under the driver's seat. Please check the battery status regularly to ensure that the fixed terminals are free of rust, the connection parts are not loose and cracked, and the low-voltage battery is free of expansion and leakage.

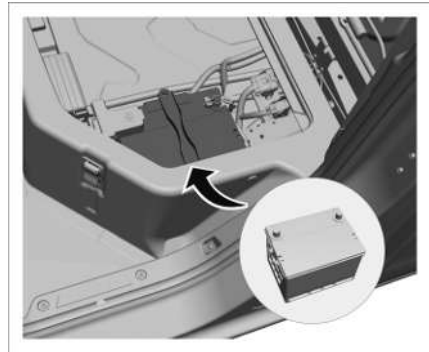

 Low-voltage battery terminals, terminals and related accessories contain lead and lead compounds, which can affect health. Therefore, wash your hands after touching these locations. ◀

In order to increase the service life of the vehicle battery and maintain normal operation of the vehicle electrical system, we offer you some suggestions below:

- Prevent overcharge or long-term power loss of the low-voltage battery.
 - The battery shall be kept away from heat source and open fire and well ventilated during charging and utilization of the battery to prevent fire and injuries.
 - Prevent long-term high-current discharge of the low-voltage battery.
 - The low-voltage battery should be installed firmly on the vehicle to reduce vibration.
 - Frequently check whether the fixing clips of the low-voltage battery ports are firm and in good contact, so as to prevent sparks and causing explosion of the low-voltage battery. Oxides and sulfates produced by fixing clips of the low-voltage battery must be scraped off and coated with Vaseline to prevent further corrosion.
 - If the battery leaks fluid, do not touch it as it may be a strong acidic electrolyte from the battery. If your skin or eyes come into contact with electrolyte, wash them immediately with plenty of water. Get medical attention as soon as possible to avoid serious injury.
- ⚠** When the vehicle operates in a cold area, it is necessary to avoid complete discharge of the low-voltage battery to prevent the electrolyte from freezing. ◀

Battery inspection

This vehicle is equipped with a maintenance-free low-voltage battery, and there is no need to add low-voltage battery solution.

There is a battery status detection observation hole on the top of the battery, and the battery status can be judged by regularly checking the observation hole.

- The colour of observation hole is green - the battery is in good condition
- The colour of observation hole is black - the battery needs to be charged
- The colour of observation hole is white - the battery needs to be replaced

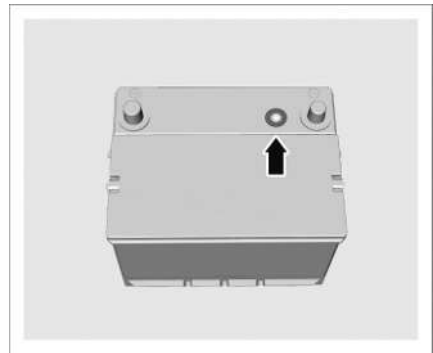

- i** If the colour in the observation hole is colourless, gently tap it with a suitable tool to discharge bubbles. If the colour in the observation hole does not change, the battery must be replaced. ◀

Charging or Replacing the Battery

Due to natural discharge and loss effect of specific electrical equipment, the battery will suffer from gradual loss of power, even if the vehicle is not used. If the vehicle is idle for a long time, the battery may run out and the vehicle cannot enter READY mode. When the vehicle is running, the power battery will charge the low-voltage battery.

The hydrogen gas produced by the battery is flammable and explosive when it is charged. Therefore, the following precautions shall be observed before charging:

- Try to remove the battery for charging. When charging a battery that is still installed in the vehicle, be sure to disconnect the negative cable.
- When connecting and disconnecting the charger cable from the battery, make sure the power supply switch of the charger is off.
- Pay attention to the warning labels, specifications and models pasted on the low-voltage battery.

 The battery contains toxic corrosive sulfuric acid and may produce inflammable and explosive hydrogen. To reduce the risk of serious injury or even death, observe the following

precautions when handling batteries or working near them:

- Be sure to charge the vehicle in an open space. Please do not charge the battery in poorly ventilated garages or enclosed rooms.
- Do not allow tools to contact the battery terminals and generate sparks;
- Do not smoke or strike matches near the battery;
- Be sure to wear safety goggles when working near the battery;
- Please keep children away from the battery.
- If the electrolyte splashes into eyes, immediately flush eyes with clean water for at least 15 minutes and seek medical advice immediately. If possible, continue to clean your eyes with an absorbent sponge or cloth while seeking medical attention.
- If the electrolyte splashes on your skin, please thoroughly clean the contact area. In case of burning and pain, seek medical advice immediately;
- If the electrolyte splashes on clothes, it may penetrate the clothes and contact with skin. Please take off your clothes

immediately and take the above measures if necessary;

- If the electrolyte is swallowed, drink plenty of water or milk. Take milk containing magnesium oxide, stirred raw eggs or vegetable oil and seek medical advice immediately.



When replacing the low-voltage battery, a new one of the same model and specification must be used. Please contact a Farizon Auto after-sales service station for maintenance, replacement and installation of the battery.



After replacing the low-voltage battery, please send the old battery to a Farizon Auto service station for disposal, or send it to a recycling station that meets the relevant environmental protection laws. There is corrosive acid in the low-voltage battery. Please keep the front side up during transportation and storage. Be careful not to let the low-voltage battery fall to the ground. ◀

Long-term storage of vehicles

The parking position of the vehicle should help to prevent deterioration of the vehicle condition and facilitate the restarting of the vehicle. If possible, please park the vehicle in the garage as much as possible. Please fully charge the vehicle,

thoroughly clean and dry the body surface.

As there will be weak current consumption in the vehicle circuit system during parking, standing still for a long time will cause the low-voltage battery to run out and thus the vehicle cannot be started. Therefore, if you want to store the vehicle for a long time, disconnect the negative cable of the battery to prevent the low-voltage battery from discharging and causing too low power.

Washer fluid and wiper blade

Washer fluid

Position of washer fluid reservoir

The washer fluid reservoir is located in the middle of the front engine compartment.

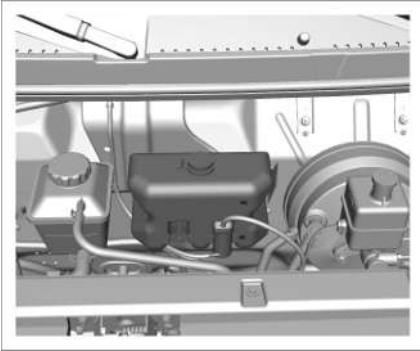

What kind of washer fluid to use

Before using the windshield washer fluid, please read the manufacturer's instructions. If the temperature in the area where you drive may drop below 0°C, use a washer fluid with sufficient antifreeze ability.

- ⚠ The freezing point temperature of the washer fluid shall be more than 10°C lower than the local minimum air temperature.



Filling of washer fluid

Open the glass washer fluid reservoir cover and add washer fluid to "MAX" position.

- i In cold weather, the washer fluid reservoir can only be filled to three fourths of its volume to allow expansion of the washer fluid when it is frozen and avoid damage due to lack of expansion space.

- ⚠ If concentrated washer fluid is used, please add water to dilute

it according to the manufacturer's instructions.

Do not add water to the ready-to-use washer fluid. Adding water may cause the washer fluid to freeze and damage the washer fluid reservoir or other parts of the scrubber system. Moreover, the cleaning ability of water is not as good as that of washer fluid. ◀

Wiper blade

- ⚠ Grease, silicon and petroleum products tend to weaken the wiping effect of wiper blades. Wash the wiper blades in warm soapy water and check their condition regularly.

Clean the windshield frequently, and try to avoid using the wiper blades to clear the sand on the windshield, so as not to affect the wiping effect of the wiper blades and reduce their service life.

If rubber hardening or cracks are found, or the wiper scratches the windshield or it cannot wipe a certain area, the wiper blade needs to be replaced.

Clean the windshield regularly with appropriate washer fluid, and ensure that the windshield is thoroughly cleaned before replacing the wiper blade. Use the wiper blade of the same

specification as the genuine wiper only.

If the wiper or windshield is covered by ice and snow or is frozen, clean off the ice and snow before using the wiper blade so as to avoid damage of wiper.

When the windshield is dry and there are hard objects on its surface, do not use wiper; otherwise, wiper blade and windshield may be damaged. ◀

Replacement of wiper blade

Check whether the wiper blade is aged, worn or broken. To replace the wiper blade:

1. Pull the wiper blade assembly away from the windshield.
2. Press the wiper blade fixing tongue, and pull the wiper blade in the direction of arrow to loosen it from the wiper arm.

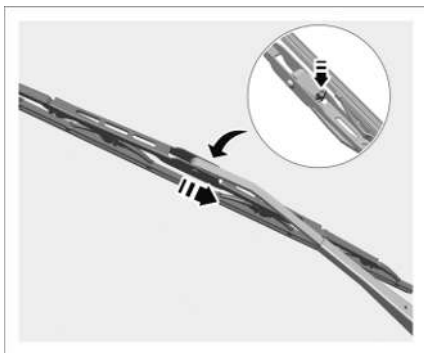

3. Remove the wiper blade.

⚠ When the wiper blade is not installed, do not allow the wiper

arm to contact the windshield; otherwise, the windshield will be damaged. Any damage caused by this is not covered by the vehicle warranty. ◀

4. Install the wiper blade in reverse order.

Tire

Overview

If you have any questions about tire warranty and service shop, please refer to the vehicle's Warranty and Maintenance Manual for details. Please consult the tire manufacturer for other information.

⚠ Overload on tire will cause overheat of tires due to excessive deflection. The tires may have air leakage and cause severe accidents.

Lack of maintenance and improper use of tires are very dangerous.

Under-inflation of tires is as dangerous as overloading of tires. The resulting accident may cause serious personal injury.

Always check all tires to maintain the recommended pressure.

Check the tire pressure when the tire is in cold status. Please refer to "Wheel and Tire Parameters" [▶ 142] in Chapter 9 "Technical Data".

A tire that is overinflated is more likely to scratch, puncture or burst due to sudden impact, such as hitting into a pothole. Therefore, the tires should maintain the recommended pressure.

Worn tires can cause accidents. If the tire tread is seriously worn or the tire is damaged, it should be replaced in time. ◀

Winter Tire

If you expect to drive on snow-covered roads frequently, it is best to use winter tires. Although all-weather tires can provide good overall performance on most surfaces, they may not provide the friction force you expect or the same performance level as winter tires on snow-covered roads.

Generally, winter tires are used to increase friction on snow-covered roads. When winter tires are used, the following phenomena may occur: reduced traction on dry roads, increased noise on roads and shortened service life of tire tread. After changing to winter tires, beware of the changes in vehicle control and braking. Please consult a Farizon Auto after-sales service station for details of winter tire supply and selection of suitable tires. If you choose to use winter tires:

- Use tires of the same brand and tread pattern at all four wheel positions.

- Use only radial tires with the same dimensions, load range and rated speed as the genuine tires.
- If you choose to use winter tires with a lower rated speed, do not exceed the maximum rated speed of the tires.

Tire pressure

Tires must have the correct inflation pressure to work effectively. Please refer to "Wheel and Tire Parameters" [▶ 142] in Chapter 9 "Technical Data" for tire inflation pressure.



If the tires do not have enough air (under-inflation), the following conditions will occur:

- Excessive deflection and deformation
- Overheating
- Tire overload
- Poor handling stability

If the tires have too much air (over-inflation), the following conditions will occur:

- Abnormal wear
- Poor handling stability
- Poor riding comfort.
- Unnecessary damage caused by dangerous road conditions. ◀

Tire Pressure Monitoring System (TPMS)

This vehicle is equipped with an indirect tire pressure monitoring system. The working principle of the

connection-type tire pressure monitoring system is that when the tire pressure decreases, the weight of the vehicle will reduce the rolling radius of this wheel, resulting in its speed faster than other wheels. At the same time, the resonance frequency of this wheel will decrease. The purpose of monitoring tire pressure is achieved by comparing the difference between rotation speed and resonance frequency among tires. The indirect tire warning system actually monitors the tire pressure by calculating the rolling radius and resonance frequency of the tire.

If the TPMS abnormal tire pressure warning lamp illuminates, it indicates that one or more tires are underinflated. At this time, pull over as soon as possible. Check the tire pressure and inflate the tire to the correct pressure value. Driving with underinflated tires will cause tire overheating and fault. In addition, it will shorten the tread life and may affect the vehicle's handling performance and braking performance. Adjust the tire pressure to the recommended parameter in "Tire Pressure (Cold State)" in "Technical Data".

TPMS Calibration

Inflate all tires to the specified pressure. Click **Vehicle Settings - Tire Pressure Management** on the central control screen menu. Click the "Tire" button for initialization. If the

calibration fails, the central display will show the calibration failure information.



The system must be calibrated in the following cases:

- Adjustment of inflation pressure of one or more tires;
- Replace the tire;
- Dynamic balancing for wheels;
- The chassis is technically modified.
- The ambient temperature has changed by more than 40°C since the last calibrator;
- After half a year or 10,000 km.

Tire inspection and rotation

When to check tires

Check the tire (including spare tire) at least once a month. When checking tire inflation status, you should also check that there is no external damage, embedded foreign objects or excessive wear, etc. If any of the following circumstances are found, you should replace the tire as soon as possible:

- 1 There is damage and bulging in the tire surface or side. If any of the conditions is found, replace

the tire. If the tire fabrics or cords are exposed, replace the tire.

- 2 There is excessive wear to the tire tread.

How to check the tires

Check the inflation pressure of the tire when it is cold. A tire in cold status means that your vehicle has stopped for more than three hours or traveled no more than 1.6 km. Remove the valve cap from the tire valve core. Press the tire pressure gauge firmly onto the valve and measure the pressure reading. If the inflation pressure of the tire in cold status meets the recommended pressure value on the tire pressure label, no adjustment is required. If the inflation pressure is too low, continue to inflate to the recommended pressure. If the tire is overinflated, use a tire pressure gauge to deflate to the recommended air pressure value. Be sure to install the valve cap back onto the valve core. Valve cap can prevent dust and moisture from entering the valve.

Tire rotation

We recommend that you regularly check the tires of your vehicle for signs of wear or damage. Please refer to "When to Use New Tires" in this chapter for details. Please refer to the provisions in Warranty and Maintenance Manual for specific time of tire rotation. The purpose of regular tire rotation is to make all

tires of the vehicle wear evenly. This can ensure that the vehicle always has the performance closest to that when the tires are brand new. As long as abnormal wear is found, tire rotation should be carried out as soon as possible and wheel alignment should be checked. In addition, check whether the tires or wheels are damaged. Please refer to "Selection of New Tires" [▶ 130] and "Wheel Replacement" [▶ 132] in this chapter.

In order to prolong the service life of tires, it is recommended that tire rotation be carried out every 10,000 km or so according to the following scheme, as shown in the figure below. After tire rotation, adjust the inflation pressure of front and rear tires according to recommended parameters. Please refer to "Tire Pressure" [▶ 127] in this chapter.

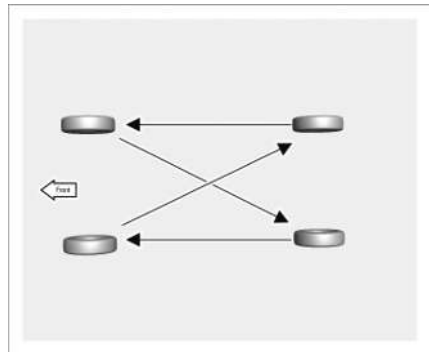

 Rust or dirt on wheels or wheel connectors will make wheel nuts loose after a certain period of use. The wheels may fall off, resulting in accidents. During

wheel replacing, please remove any rust or dirt from the connection between the wheels and the vehicle. In case of emergency, clean with cloth or tissue; however, if necessary, be sure to use scraper or wire brush to remove all rust or dirt after the emergency situation. ◀

Selection of new tires

When to use new tires

Various factors, such as maintenance, temperature, driving speed, vehicle load, and road conditions, will affect the cycle you need new tires.

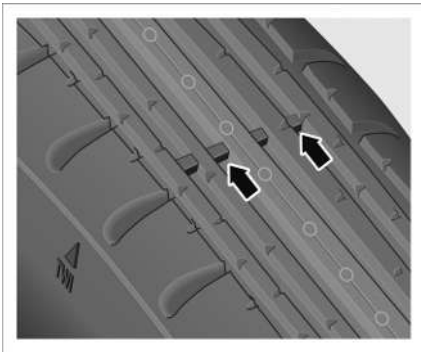

The tread wear mark indicator is molded on the side wall of each tire and represented by TWI or Δ marks. When the tread pattern is worn close to the wear mark, replace the tire in time. Continuous use of tires with shallow tread patterns or exposed wear marks will lead to extended braking distance, steering failure and tire breakage, resulting in accidents. In addition to proper inflation, the correct wheel alignment also aids in reducing tire wear. If uneven tire

wear is found, please go to a Farizon Auto after-sales service station to check the wheel alignment status.

A new tire is required if one of the following conditions occurs:

- You can see a cord or fabric be exposed through the tire rubber.
- Tread or sidewall is broken, cut or cracked, and it is deep enough to see the cord or fabric.
- The tire is bulging or delaminated. The tire is punctured, cut or otherwise damaged, and cannot be completely repaired due to the damage area or location.

The quality of rubber in tires will deteriorate over time, even if these tires have never been used. There are many conditions that affect the rate of aging, including temperature, load condition, and inflation pressure maintenance. If the tire is not properly maintained, it will usually wear out before it deteriorates due to aging. If you are not sure when you need to replace the old tire with a new one, please consult the tire manufacturer for more information.

 Please dispose of used tires in accordance with relevant environmental protection laws.



Buy new tires

When purchasing new tires, make sure that their dimensions, load range, rated speed and structure type are the same as those of the genuine

ones. In this way, the performance of the vehicle will be as good and as safe as before under normal use after tire replacement. It is recommended to replace the tires together. This is because the uniform tread depth on all tires will help to maintain the performance of the vehicle most similar to that when the tires are brand-new. If the four tires are not replaced together, it may affect the braking and maneuverability performance of the vehicle. Refer to the "Tire Inspection and Rotation" [▶ 128] section in this chapter for information on proper tire rotation.

 Mixing tires will cause the vehicle to get out of control while driving. If you mix tires of different sizes or types (radial tires or bias belted tires), the vehicle may crash due to poor maneuverability. Using tires of different sizes or types may also damage the vehicle. Tires of the correct size and type should be used on all wheels. ◀

 If diagonal ply tires are used on the vehicle, the rim flange will crack after a certain mileage. Tires or wheels will suddenly get out of control and cause a crash. Therefore, only radial tires can be used on your vehicle. ◀

Tires and wheels of different sizes

If you use wheels or tires with different sizes from the original ones, it may affect the performance of your vehicle, including braking, driving and maneuverability, stability, and rollover resistance, etc.

In addition, if your vehicle is equipped with electronic systems, such as anti-lock braking, these systems will also be affected.

 If you choose tires with specifications other than those recommended in this manual, your vehicle may not provide satisfactory performance and safety performance, and it may increase the possibility of crash and serious injury. Only use the specific wheels and tire systems specially developed for your vehicle, and have a Farizon Auto after-sales service station install them correctly. ◀

Wheel alignment and tire balance

In order to maximize the tire life and provide the best overall performance, tires and wheels have been carefully aligned and balanced before leaving the factory. It is not necessary to adjust wheel alignment and tire balance regularly. However, if abnormal tire wear or vehicle deviation is found, check the wheel alignment. If the vehicle bumps on a smooth road, it may be necessary to

rebalance the tires and wheels. Please contact the Farizon Auto after-sales service station for maintenance as soon as possible.

Unbalanced wheels will affect the operation of the vehicle and the service life of tires. After tire repair, they shall be dynamically balanced as required. Check the dynamic balance of tires after driving for a long time.

Rim	Tire	Unbalance
15×6J	195/70R15L T 12PR	≤ 10 g

Wheel Replacement

Wheels that are bent, cracked or severely rusted or corroded should be replaced. If the wheel nuts often become loose, replace the wheel, hub and wheel nuts. If the wheel leaks, it should be replaced. If any of the above situations occurs, please consult a Farizon Auto after-sales service station. Geely service station knows what kind of wheels you should use. The new wheel should have the same load capacity, diameter, width and eccentricity as the replaced one, and the installation method should be the same. If any wheel or wheel nut needs to be replaced, only new original Geely parts shall be used for replacement. In this way, it can be ensured that the wheel or wheel nut is matched with the vehicle.

 It is dangerous to use inappropriate replacement wheels and wheel nuts on this

vehicle. This will affect the braking and maneuverability performance of the vehicle, make the tire leak, and cause losing control of the vehicle. It may cause an accident and injure you or others. Therefore, be sure to use the correct wheels and wheel nuts for replacement. ◀

 Inappropriate wheels will also lead to problems in terms of bearing service life, brake cooling, speedometer or odometer calibration, headlamp beam-focusing, bumper height, ground clearance, clearance between tire or tire chain and vehicle body and chassis, etc. ◀

Use Old Wheels

It is also very dangerous to install old wheels on this vehicle. You do not know how the old wheels have been used and how many miles they have travelled. They will suddenly break down and cause an accident. If you need to replace wheels, be sure to use new original ones.

Tire chain

 Antiskid chains are not included in the scope of this vehicle's equipment. The following information is only for your reference. ◀

Please add antiskid chains according to the actual road conditions.

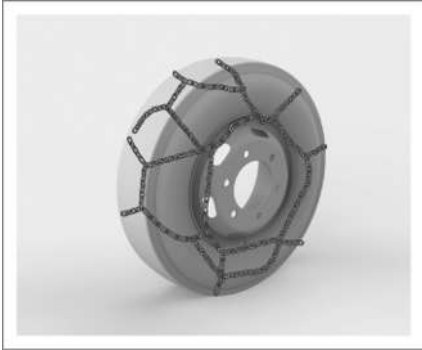

When the tire chains are used, try to avoid full load. In addition, drive carefully at a low speed. Otherwise, the vehicle will be damaged or the maneuverability of the vehicle will be affected.

When installing antiskid chains, select chains that are suitable for the size of your vehicle tires, and install them in strict accordance with the manufacturer's instructions.

 Do not use antiskid chains on dry roads. ◀

In case of a flat tire

The following phenomena will occur in case of a flat tire during driving. Please take corresponding measures according to the specific situation:

1. In case of a front flat tire, the drag of the flat tire will cause the vehicle to run towards the side of the flat tire. Please release the accelerator pedal and hold the steering wheel firmly. Turn the vehicle to keep in the original lane, then gently depress the brake pedal and pull over to a

safe side of the road as much as possible.

2. In case of a rear flat tire, please release the accelerator pedal. In case of a rear flat tire on a curve, it is much like a side slip, so the same measures as those for a side slip should be taken. Turn the steering wheel in the direction you want the vehicle to travel to maintain control of the vehicle. It may be bumpy and noisy, but you can still control the steering. Then gently depress the brake pedal and pull over to a safe side of the road as much as possible.

Tire burst is not common when the vehicle is running. Proper maintenance and careful driving of tires can reduce the probability of tire burst.

Vehicle cleaning and maintenance

External cleaning

Frequent washing helps preserve your car's appearance. When washing the vehicle, turn off the power supply of the vehicle (turn it to OFF position) and wash in a cool place. Do not wash under direct sunlight. If your vehicle is exposed to the sun for a long time, wait until the exterior cools down before washing. Follow the instructions of the operator when using an automatic car washer.

Before washing the vehicle, check and confirm that the doors, windows

and charging port cover plate on the vehicle are closed.

 To prevent damage to the vehicle paint, corrosive substances (guano, resin, insects, asphalt spots, paving salt, industrial dust, etc.) shall be removed immediately. If necessary, remove asphalt spots and stubborn oil stains with industrial alcohol, and then immediately wash them with water and mild neutral soap solution to remove alcohol. ◀

Clean the vehicle with a high-pressure washer

- Before washing the vehicle, check and confirm that the charging port cap has been closed correctly.
- Be sure to clean the vehicle in strict accordance with the operation instructions of the high-pressure washer, and pay special attention to its working pressure and spray-washing distance. If a pressure washer is used, the nozzle must be kept at least 30 cm away from the surface of the vehicle body. Keep the nozzle moving and not spraying water continuously towards a certain area. High-pressure water flowing into vehicle components may cause damage. Do not spray water from the nozzle towards the charging port.
- Do not clean the vehicle with a "cluster nozzle".
- Do not flush the engine compartment directly or indirectly with the nozzle. High-pressure water flow may damage the electrical components in the engine compartment or cause some components to fail to work normally.
- Do not flush the water gun nozzle by aligning it with the HV components and connectors at the bottom of the vehicle disc (especially connecting orange HV harness connectors).
- Do not use a high-pressure washer or steam cleaner to clean the camera and sensor, so as to avoid damage.
- Do not spray painted bumpers, rubber hoses, plastic parts, insulating materials and other soft components at close range.
- Do not directly flush the door seam, roof seam, joints and other parts.

Clean the vehicle with an automatic vehicle washer

- Before automatic vehicle washing, please check with the automatic cleaner operator whether the vehicle has any additional components and follow the advice of the operator.
- The exterior rearview mirror shall be folded before washing the vehicle.

- The strength of the body paint surface is enough to withstand the washing of the automatic cleaner. However, attention must be paid to the influence of the automatic cleaner on the body paint surface during automatic cleaning, and the influence degree mainly depends on the structure of the automatic cleaner, the cleaning brush, the filtering state of the cleaning water, and the type of cleaning agents and wax solvents. If it is found that the paint surface of the vehicle body becomes dark or scratched after washing, notify the operator immediately to correct it.
- Use an automatic vehicle washer to wash the vehicle, and try to use a contactless vehicle washer. This type of vehicle washer does not have parts (brushes, etc.) that touch the body surface.

Interior cleaning

Frequent cleaning of the interior is conducive to improving the environment. Dust and dirt can accumulate on the interior and cause surface damage to carpets, fabrics, leather and plastic products. Stains shall be removed quickly, especially for light-coloured interior. Otherwise, extremely high temperature will cause them to cure rapidly.

Use a small soft brush to remove dust from small buttons and knobs.

Only professional detergent can be used to clean the interior surface of

the vehicle, otherwise permanent damage may be caused to the vehicle. In order to prevent excessive spraying, the cleaning agent should be sprayed directly on the cleaning cloth. If the cleaning agent is accidentally sprayed on the surface of other objects in the vehicle, wipe it off immediately.

The temperature of the drying gun used to paste the glass protective film is extremely high. Pay attention not to bake the interior when pasting the protective film, otherwise it will cause damage to the interior.



Do not use abrasive cleaner when cleaning the glass surface on the vehicle; otherwise, it will scratch the glass or cause poor light transmission. Use only soft cloth and glass cleaner. ◀

Cleaning agents contain solvents that condense on the interior of the vehicle. Before using the cleaning agent, please read and follow all safety instructions on the label.

When cleaning the vehicle interior, please open the doors and windows to ensure good ventilation.

Please pay attention to the following items when cleaning interior:

- Do not use blades or other sharp objects to remove dirt from the interior surfaces.
- The use of scrubbing brushes is prohibited. It may damage the interior surface of the vehicle.

- Do not press or wipe with a cleaning cloth forcibly. Excessive force cannot improve the descaling effect. On the contrary, it will damage the interior.
- Use mild neutral soap only. Avoid using strong detergents or degreasing soaps. Too much soap will leave traces and stick dirt.
- Do not wet the interior when cleaning.
- Using some organic solvents, such as naphtha and alcohol, will damage the vehicle interior.

Fabric/Carpet

Use a vacuum cleaner with a soft brush head to remove dust and scum. For stubborn stains, water or soda water can be used to try to remove the stain first. Before cleaning, please select an appropriate method to remove stains:

- For liquid stains: Use tissue to gently wipe the remaining stains. Try hard to soak the stains and adsorb them into tissues.
- For solid dry stains: remove them as much as possible, and then use a vacuum cleaner to remove them.

Cleaning steps:

1. Soak a clean, lint-free white cloth with water or soda water.
2. Wring the cloth dry to remove excess water.
3. When removing the stains, gently scrub from the edge to the

middle until there is no more stain on the cloth.

4. If the stain cannot be completely wiped off, repeat the above steps with mild soapy water.

If stubborn stains cannot be completely removed, consider using a chemical fiber cleaning agent or detergent. Before using these products, perform the color fastness test in an inconspicuous small place inside the vehicle. If the local cleaning effect is good, it can be used to clean the whole surface. After cleaning, paper towels can also be used to absorb excess moisture on fabrics or carpets.

Cleaning Leather

A soft cloth dipped in water can be used to remove dust. If more thorough cleaning is required, wipe it with a soft cloth dipped in neutral soapy water. Please let the leather dry naturally. Do not dry it, and do not use steam to clean the leather.

It is forbidden to use detergent and polishing agent on the leather, otherwise it may permanently change the appearance and hand feeling of the vehicle interior. Do not clean the vehicle interior with silicone-based products, wax-based products or products containing organic solvents, which may cause uneven glossiness of the leather and affect the aesthetics of the interior. Never use shoe polish on leather.

Instrument panel and other plastic surfaces

Do not use detergent and polishing agent on the plastic surface, otherwise it may permanently change the appearance and hand feeling of the vehicle interior. Some commercially available products may enhance the glossiness of instrument panel, which will reflect light on windshield and seriously affect the visual permeability of windshield.

Main parameters of vehicle

Main dimensional parameters

Item	Unit	V6E
Vehicle length	mm	4845
Vehicle width	mm	1730
Vehicle height	mm	1985
Front wheel tread	mm	1484
Rear wheel tread	mm	1471
Wheelbase	mm	3100



According to the Chinese standard GB1589-2016, exterior components (such as rearview mirrors, signs and handles) are not included in the measurement range of the vehicle's external dimensions (length, width and height). ◀

Vehicle mass parameters

Item	Unit	V6E
Seating capacity	person	2
Curb weight	kg	1565
Full-load weight	kg	2715
Mass of front axle (full-load weight)	kg	980
Mass of rear axle (full-load weight)	kg	1735

Main characteristic parameters of vehicle

Item	Unit	V6E
Drive mode	-	Rear-engine rear-drive
Minimum ground clearance	mm	155
Minimum turning diameter	m	12.5
Approach angle	°	30
Departure angle	°	20
Front suspension types	-	MacPherson independent suspension
Rear suspension types	-	Leaf spring type non-independent suspension (5 pieces)

Brake system parameters

Item	Unit	V6E
Free stroke of brake pedal	mm	15~20
Brake type	Front	Disc brake
	Rear	Drum brake
Normal thickness of front brake pad	mm	9.5
Wear limit of front brake pad	mm	2
Normal thickness of front brake disc	mm	22
Wear limit of front brake disc	mm	20
Normal thickness of rear brake shoe	mm	5
Wear limit of rear brake shoe	mm	2
Normal inner diameter of rear brake drum	mm	270
Wear limit inner diameter of rear brake drum	mm	272

Main parameters of drive motor

Item	Unit	V6E
Drive motor type	-	Permanent magnet synchronous motor
Rated power of drive motor	kW	50
Peak power of drive motor	kW	100
Rated torque of drive motor	N•m	130
Peak torque of drive motor	N•m	300
Peak speed of drive motor	r/min	10000
Rated voltage	V	336

Main parameters of power battery

Item	Unit	Parameter
Battery brand	-	CATL
Battery type	-	Lithium iron phosphate
Battery capacity	kWh	41.86
Energy density	Wh/kg	137.6
Rated voltage	V	334.88
Battery capacity	Ah	125
Battery charging time	h	Fast charging at normal temperature: about 1.5h (SOC: 20%~100%) Slow charging at normal temperature: about 6.7h (SOC: 20%~100%)

Vehicle dynamics

Item	Unit	V6E
Maximum speed	km/h	105
Maximum gradeability	%	28
WLTC driving range	km	195

Wheel and tire parameters

Item	V6E
Tyre model	195/70R15LT 12PR
Wheel model	15×6J

Tire Pressure (cold state)

Item	Unit	V6E
Front wheel	PSI	60
	bar	420
Rear wheel	PSI	78
	bar	540

Wheel alignment parameters (unloaded)

Item	V6E	
Front suspension	Wheel camber angle	45'± 40'
	Kingpin inclination angle	8°54'± 45'
	Kingpin caster angle	3°5'± 45'
	Front wheel toe-in	6'± 6'

Oil

Recommended oil and capacity

Item	Specifications	Quantity	Remarks
Coolant	-40°C glycol-based coolant	6.3 ± 0.3 L	Between MAX and MIN marks
Rear axle final drive gear oil	GL-5 75W/90	2.4±0.1 L	
A/C refrigerant	R1234yf	460±10 g	
Brake fluid	DOT4	0.59± 0.1 L	Between MAX and MIN marks
Windshield washer fluid	-25°C washer fluid	1.0 L	Between MAX and MIN marks

A	
A/C ventilation system.....	51
Acoustic vehicle alerting system	93
Adding of coolant.....	116
Air outlet adjustment and A/C maintenance	52
Airbag deployment	65
Airbag malfunction indicator.....	67
Anti-theft System	71
B	
Backup power supply	46
Battery inspection.....	122
Braking energy recovery	119
Bulb specifications.....	108
C	
Cargo car body	94
Charging interface	20
Charging operation.....	21
Charging or Replacing the Battery	123
Chassis fuse box	102
Check or replace the fuse	106
Check the coolant	115
Cockpit Overview	25
Common Information	27
D	
Descriptions of A/C control system button	49
Driver's seat.....	54
Driving gauges.....	26
Driving precautions	76
E	
Electric window	42
F	
Electronic stability control system (ESC)	86
EPS	120
Exterior rearview mirror.....	40
External cleaning.....	133
G	
Getting vehicle out of trap	111
Graphic information	6
H	
Hazard warning lamp	97
Horn.....	39
HV safety	14
I	
In case of a flat tire.....	133
Instrument fuse box	104
Instrument panel switch group	44
Interior cleaning	135
Interior handle.....	46
Interior lamp.....	43
Introduction to cooling system	115
Introduction to warning lamps and indicators.....	31
L	
Location of vehicle identification mark.....	7
Long-term storage of vehicles	124

M	
Main characteristic parameters of vehicle.....	140
Main dimensional parameters.....	138
Main parameters of drive motor .	141
Main parameters of power battery	141
Maintenance of seat belt	63
Maintenance, repair, recycling and scrapping.....	16
Mechanical parking brake.....	85
N	
Notes to users	5
O	
On-board tools.....	112
Operation instructions of multimedia player	53
Operation of light control combination switch.....	34
Overview of A/C control system.....	48
Overview of airbag.....	63
Overview of instrument cluster	26
Overview of pure electric powertrain	13
Overview of seat belt.....	58
P	
Passenger seat	56
Precautions.....	42
Precautions for Brake System.....	117
Precautions for charging.....	18
Prompt information.....	6
R	
Recommended oil and capacity...	143
Regular maintenance	113
Remote control key.....	69
Reversing image	92
Reversing radar system.....	90
S	
Seat adjustment parameters.....	57
Seat belt unfastened warning	62
Seat ventilation and heating.....	56
Selection of new tires	130
Service brake	84
Shift information	82
Start switch	74
Steering wheel button	38
Steering wheel heating.....	40
Storage space	45
Sun visor.....	47
T	
Tire chain.....	132
Tire inspection and rotation	128
Tire overview	126
Tire pressure.....	127
Tire pressure monitoring system (TPMS)	127
Towing hook	101
U	
Unlocking and Locking	71
USB interface	46
Use of seat belt.....	61
Utilization and maintenance of battery.....	121
V	
Vehicle collision	110
Vehicle dynamics.....	142
Vehicle fire	111
Vehicle identification marking.....	6

Vehicle jump start	97
Vehicle mass parameters.....	139
Vehicle nameplate	9
Vehicle over-temperature	109
Vehicle overview	10
Vehicle start failure.....	75
Vehicle starting procedure	75
Vehicle transportation.....	99

W

Warning information	15
Warning lamps and indicators	29
Warning triangle	97
Washer fluid	124
Wheel alignment and tire balance	131
Wheel and tire parameters.....	142
Wheel Replacement.....	132
Winter Tire	127
Wiper blade	125
Wiper control combination switch..	37